

Contents

Contents	i
Chapter One Summary	1
1.1 Introduction	1
1.2 Intended use & Indicatioins for use	2
1.3 ALARA	2
1.4 Standards	2
1.5 Service life	4
1.6 Operating conditions	4
1.7 Declaration of electromagnetic compatibility	4
1.8 Manufacturer declarations	5
1.9 Contraindications	5
1.10 Promulgation of heat index and mechanical index	6
Chapter Two Cautions and Warnings	7
2.1 Pre-scan checks	7
2.2 Safety preparation before operation	7
2.3 Operation instructions	7
2.4 Notice after operation	7
2.5 Conditions to avoid	8
2.6 Cautions when handling the device	8
2.7 In case of device failure	8
2.8 Regular check and maintain	9
2.9 Do not disassemble the device and the probe at random	9
2.10 Power on	9
2.11 Power off	9
Chapter Three System Introduction	10
3.1 Figuration	10
3.2 Specification	11
3.3 Block diagram	12
3.4 Basic Principle	13
3.5 Device constituent	13
Chapter Four Installation	14
4.1 Unpacking inspection	14
4.2 Installation	14
4.2.1 Battery installation and removal	14
4.2.2 Base Placement Diagram	15
4.3 Power supply	16
4.3.1 Battery power supply	16
4.3.2 Battery power charging	16
Chapter Five User Interface	17
5.1 Expert mode	17
5.2 Easy mode screen	18
5.3 System settings	19

Chapter Six Operation	20
6.1 Bladder scanning	20
6.2 Store information	20
6.3 Parameter setup.....	21
6.3.1 Mode selection setup.....	21
6.3.2 Sound volume setup.....	21
6.3.3 Remind setup.....	21
6.3.4 Language setup.....	22
6.3.5 Device calibration setup.....	22
6.3.6 Firmware update setup.....	22
6.3.7 Version number display.....	23
6.4 View patient information	23
Chapter Seven Cleaning and Maintenance	24
7.1 System cleaning and maintenance	24
7.1.1 System cleaning.....	24
7.1.2 System maintenance.....	24
7.2 Probe cleaning and maintenance.....	24
7.2.1 Probe cleaning.....	25
7.2.2 Probe maintenance.....	25
7.3 Battery usage and maintenance.....	25
7.4 Treating and disposing of products after use	26
Chapter Eight Transportation and Storage.....	27
8.1 Transporting the system.....	27
8.2 Transportation and storage conditions	27
8.3 Transportation	27
8.4 System storage.....	27
Chapter Night Checking and Troubleshooting	28
9.1 Checking.....	28
9.2 Troubleshooting.....	28
9.3 Contacting Caresono for support when fault of device unsolved	28
9.4 Maintenance.....	28
Chapter Ten Acoustic Output.....	29
10.1 Concerns with Bioeffects.....	29
10.2 Prudent Use Statement.....	29
10.3 ALARA Principle (As Low As Reasonably Achievable).....	29
10.4 Acoustic Output	30
10.4.1 Derated Ultrasonic Output Parameters	30
10.4.2 Limits of Acoustic Output.....	30
Appendix A: Labeling	31
HD 2 Main unit labeling.....	31
HD 2 Outer Package labeling	31
Appendix B: Acoustic Output Report.....	33
Appendix C: Definitions and Symbols	34

Chapter One Summary

Statement:

The power of interpretation of this document is the property of Caresono Technology Co., Ltd.

Without permission from our company, this document must not be photocopied, reproduced or translated into other languages.

We preserve the right of revising the content and items on this document without any further notice.

Some operations on this document are explained by pictures and these pictures are used only for indicating without any other purpose.

Caresono is the trademark of Caresono Technology Co., Ltd.

Any abuse of these trademarks without permission will be sued to assume legal responsibility according to laws.

1.1 Introduction

The PadScan HD 2 by Caresono Technology Co., Ltd. provides real-time ultrasound imaging and measuring, and also provides non-invasive volume measurement of the bladder. It is a handheld bladder scanner; the main unit and the probe are all-in-one.

It features:

- *Expert* operating mode and *Easy* operating mode. In the expert mode, real-time 2-dimensional ultrasound image will be displayed. Doctors can decide if the location and the measurement result are right according to the cross-section image of the bladder. In the easy mode, 2-dimensional ultrasound image will not be displayed. The device instructs the operator to move the probe to find the right location. (It is not necessary for the operator to have professional ultrasonic knowledge during *Easy* operating mode.)
- Non-invasive, comfortable, correct, reliable, fast and simple operation. When the operator releases the scanning button, the bladder volume will be calculated and the value of the bladder volume will be displayed.
- SD card storage
- Voice recording function

- Urine volume setting and alarm setting
- Multi-language selection
- Injection olded shell, the main unit and the probe are all-in-one, 2.5-inch LCD screen(240x320pixels)
- Power supply with built-in battery.

1.2 Intended use & Indications for use

Intended use:

The Bladder Scanner(model: PadScan HD2) projects ultrasound energy through the lower abdomen of the patient to obtain images of the bladder which is used to calculate bladder volume noninvasively. The PadScan HD2 Bladder Scanner is intended to be used only by qualified medical professionals.

Indications for use:

The Bladder Scanner(model: PadScan HD2) is B-mode pulsed-echo ultrasound device. It intended as a handheld battery-operated device. The PadScan HD2 Bladder Scanner projects ultrasound energy through the lower abdomen of the patient to obtain images of the bladder which is used to calculate bladder Volume noninvasively. The PadScan HD2 Bladder Scanner is intended to be used only by qualified medical professionals.

1.3 ALARA

Users can not adjust the acoustic output energy of the PadScan HD2 Bladder Scanner. And the output level is below than the levels which were referred in AIUM remarks in 1992 and there were no reported biological effects under the level. However, to minimize exposure, measurements should be kept as short as possible. Refer to the acoustic output section for more information.

1.4 Standards

This device is designed and manufactured in strict accordance with:

- AAMI / ANSI ES60601-1:2005/(R)2012 And A1:2012,, C1:2009/(R)2012 And A2:2010/(R)2012 Medical Electrical Equipment - Part 1: General Requirements For Basic Safety And Essential Performance

- Type B, Class II protection to the risk of electric shock
- Degree of protection against ingress of water: IPX1(probe), IPX0 (main unit)
- Symbols:



Type B Device



Power switch



Signal output



0482 CE mark and code of certification body



Consult instructions for use



Manufacturer



Manufacturing date







Serial number

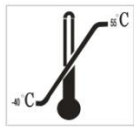

Recycled separately from other household waste under the WEEE directive

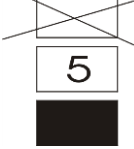
Package and transportation symbols:

	Handle with care
	Temperature limit
	Upwards
	Limited layers of storage
	Keep dry



1.5 Service life

Product life service: Six years. Continuing using the device after service life will increase the risk of failure and unpredictable risks.

Warning: Users will assume responsibility of the risks associated with the use of the device after recommended service life.

Warning: The disposal of the products should comply with the local regulations.

1.6 Operating conditions

Temperature: +5°C to +40°C

Relative humidity: 30% to 75%

Pressure: 70KPa to 106KPa

1.7 Declaration of electromagnetic compatibility

The operation of PadScan HD 2 will not interfere with other wired, wireless equipment and/or other electrical equipment. And it works properly under specified electromagnetic environment.

Warning: Use of the PadScan HD 2 under strong electromagnetic environments, close to generator, X-ray device, dental and physical therapy equipment, broadcasting stations, or buried cables, etc... may appear signal interference in the image. Stop using the PadScan HD 2 until removal of the electromagnetic interference.

Warning: Shared power supply may appear abnormal images. Eliminate the interference of electromagnetic coupling by means of test and verification.

Warning: Users replacing the equipment without prior permission from CARESONO may cause unintended electromagnetic compatibility problems. Only CARESONO-trained technicians can service the system.

1.8 Manufacturer declarations

The users will assume all the risks of changes or modifications of the device without the manufacturer's permission.

Warning: It is strictly prohibited to perform any modifications to the device without the manufacturer's permission.

Warning: Modifications must be inspected and tested by approved departments.

Warning: Do not allow service or maintenance the equipment while used in patient.

Warning: Direct plug-in plug is considered as disconnect device, please do not place the equipment in a difficultly operation position

Warning: The contacted material has been pass the ISO 10993 certificated. There is no any hazard for patient.

1.9 Contraindications

Do not use the PadScan HD2 Bladder Scanner on following cases:

- a) Fetal use or pregnant patients.
- b) Patients with ascites.
- c) Patients with open or damaged skin.
- d) Wounds in the suprapubic region

1.10 Promulgation of heat index and mechanical index

Heat index: $PI < 0.1$ 。

Mechanical index: $MI < 0.1$ 。

Chapter Two Cautions and Warnings

To ensure safety, please read the following contents before the operation. The device shall be operated only by the professional appointed or authorized by relevant medical institutions.

2.1 Pre-scan checks

- (1) The device is normal.
- (2) Keep the device away from the hot and wet things; put the device in place to ensure the safety of operation.

2.2 Safety preparation before operation

Check if the device is intact; make sure no water, chemicals or other material spattered on the device. During operation, pay attention to the main parts of the device. If there is strange sound or smell, stop using the device until the authorized engineer solves the problem.

2.3 Operation instructions

- (1) During the operation, protect the surface of the probe and do not knock it. Always use ultrasound gel with the probe to ensure proper contact.
- (2) Keep an eye on the operation of the device and also the patients. If a device failure occurs, please turn off the power of the device immediately.
- (3) Patients must not touch the device or any other electrical equipment during examination.
- (4) Do not cover the air vent of the device.

2.4 Notice after operation

- (1) Turn off the power.
- (2) Clean the device and the probe.
- (3) Place the device on the instrument stand.

2.5 Conditions to avoid

This device should avoid the following:

- (1) Spraying water
- (2) High humidity
- (3) Poor draught
- (4) Strong sunlight
- (5) Dust environment
- (6) Gas with salt or sulfur
- (7) Chemical medicine or gas
- (8) Strong vibration and crash
- (9) Our company takes no responsibility for the risk of disassembling, refitting without our permission.
- (10) Do not immerse the probe in water or any other liquids.
- (11) Keep probe away from heat sources.
- (12) Only use the ultrasound gel which FDA listed or cleared. The use of gel is recommend. We recommend an ultrasonic gel, which is manufactured by echo-med pharmaceuticals, Inc. echo gel 200(K#955246). Other substances may damage the probe and the probe cable.
- (13) Keep the probe clean. Use neutral detergent or clean water to clean the ultrasound gel on the probe.

2.6 Cautions when handling the device

- (1) Turn off the power.
- (2) Must not drop, vibrate and hit the device.

2.7 In case of device failure

If it is suspected that the device is not working properly, turn off the power and remove the battery. Contact qualified technician for support.

2.8 Regular check and maintain

2.9 Do not disassemble the device and the probe at random

2.10 Power on

Long press the power key (approximately 2 seconds) to turn on the device and enter the user interface.

2.11 Power off

After finishing the operation for the device, long press the power key (approximately 2 seconds) to turn off the device.

Chapter Three System Introduction

3.1 Figuration

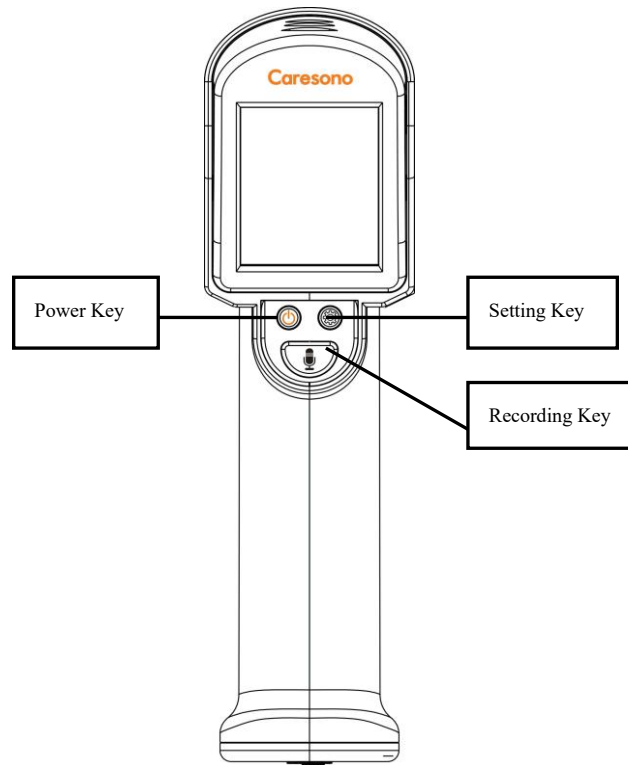

Figure 3-1 PadScan HD 2 front

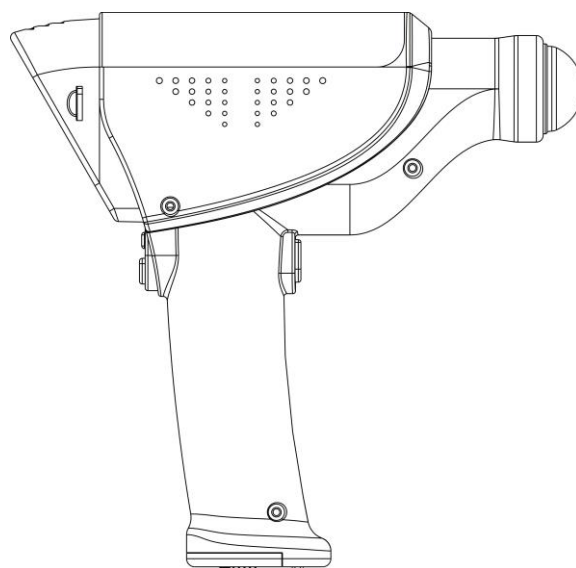

Figure 3-2 PadScan HD 2 side connection ports

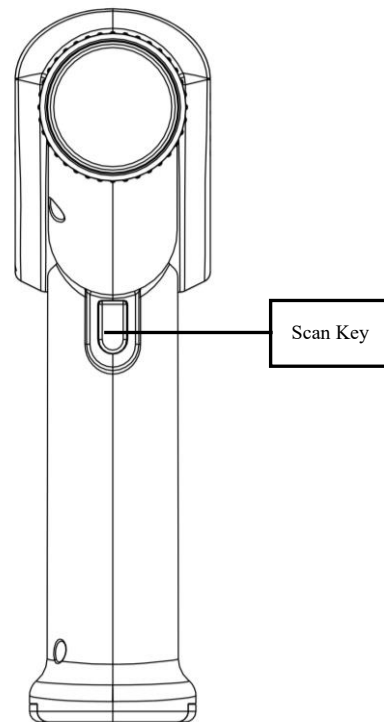

Figure 3-3 PadScan HD 2 back

3.2 Specification

- Probe: Mechanical sector probe
- Standard ultrasonic frequency of operation: 3.5MHz
- Volume measure range: 0ml-999ml
- Volume measure accuracy: $\pm 15\%$, $\pm 15\text{ml}$
- Volume display resolution: 1ml
- Battery capacity: 2600mAh
- Tissue Harmonic Imaging
- Voice recording function
- Multi-language selection
- Volume setting and remind alarm function
- Device Mode: expert mode and easy mode
- SD card information storage
- Monitor size: 2.5 inch TFT-LCD
- Consumption: 10VA
- Dimensions: 203 * 213 * 55mm

- Weight: about 500g
- Power supply: Battery DC7.4V±0.5V
- Battery time for scanning: >3.5 hours
- Battery stand by time: >8 hours
- Type of Protection Against Electric Shock: Class II for approved adapter or internally

powered

- Degree of Protection Against Electric Shock: Type B applied part
- Degree of Protection Against the Ingress of Water: IPX1 for probe
- Mode of operation: Continuous
- Applied part: probe
- Battery Charger: Model: HXY-084V1500A, input: 100-240Va.c., 50/60Hz, 0.5A Max. Output: 8.4Vd.c. 1.2A. It is considered as a part of ME equipment.

8.4Vd.c. 1.2A. It is considered as a part of ME equipment.

3.3 Block diagram

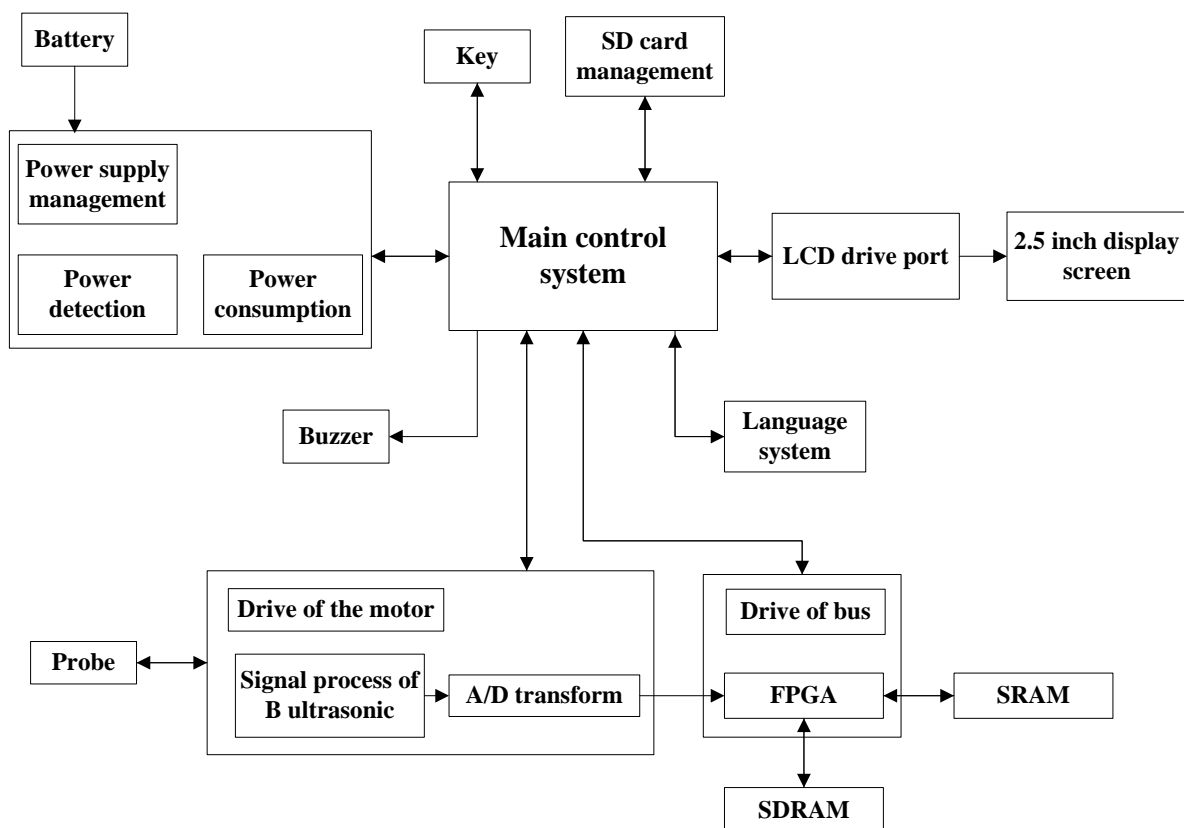

Figure 3-4 PadScan HD 2 electricity principle diagram

3.4 Basic Principle

The device utilizes a 2D Mechanical sector scanning probe to provide ultrasonic scans of the bladder and calculates the volume of the bladder through complicated computations.

Operating principle: 1. Transmits the pulse signal to the 2D probe. Launch the ultrasonic wave to the human body via the transducer of the probe (such pulses can only acquire one signal of one plane, meaning to produce a 2D image section it needs to send ultrasonic waves at least 96 or 128 times to form one section.) The ultrasonic wave transmits, or scatters, a wave through the body, and sends the received reflected signal to the DSC via the transducer, and proceeds with a series of signal processing methods: logarithms compression, detection, dynamic filter, edge enhancement, frame relevance, line relevance, etc., to form one high-definition section image to display on the screen. Then it processes the image to figure out the volume of the bladder.

3.5 Device constituent

- A main unit (including the 2D mechanical sector scanning probe: 3.5MHZ)
- Battery Charger: Model: HXY-084V1500A, input: 100-240Va.c., 50/60Hz, 0.5A , Output: DC8.4V – 1.2A
- An user manual
- Li-ion battery: model: UR18650ZY-2600mAH(SNLB-178)
- SD Card: 8G
- A packing list
- A carrying Bag
- Base

Chapter Four Installation

4.1 Unpacking inspection

After unpacking, first affirm that there is no shipping damage, then check the device according to "Packing List" and install it according to the requirements and methods described in "4.2".

4.2 Installation

4.2.1 Battery installation and removal

Battery installation:

- Slide the cover plate of the battery ① according to the reverse direction of arrow.
- ② Insert the battery into the battery slot according to the direction of arrow.
- Push the cover plate of battery ① according to the direction of arrow.

Shown as figure 4-1

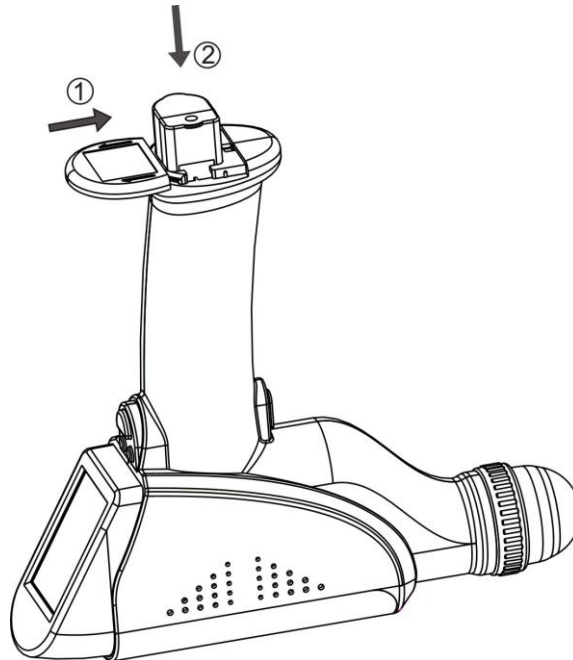

Figure 4-1 PadScan HD 2 battery installation diagram

Battery removal:

- Slide the cover plate of battery ① according to the direction of arrow.
- ② Take out the battery from the battery slot according to the direction of arrow

Shown as figure 4-2

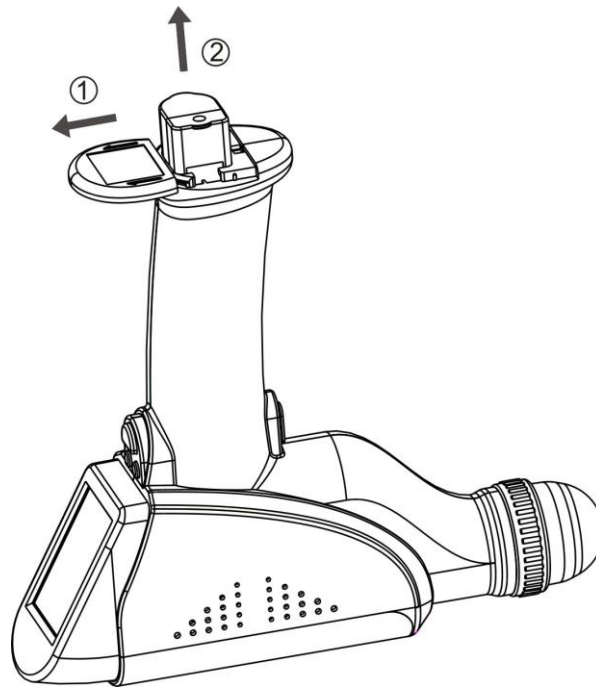
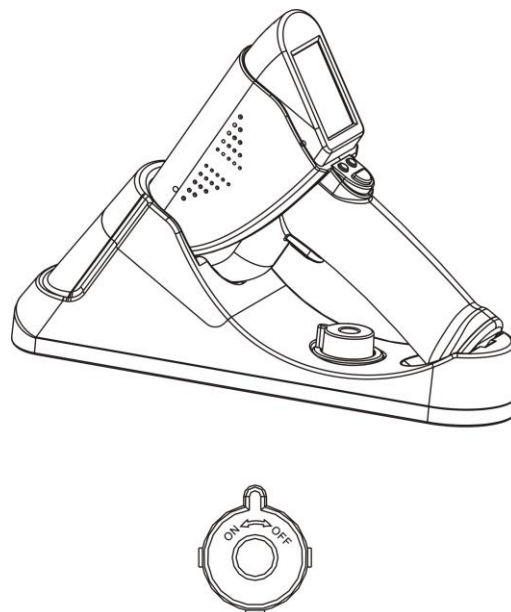

Figure 4-2 PadScan HD 2 battery removal diagram

4.2.2 Base Placement Diagram



Directions of knob in the base:

1. Base is closed tightly with table when knob turns to OFF,
2. Base is loosened from table when knob turns to ON
3. Table should be kept smooth and flat

Figure 4-3 PadScan HD2 base placement diagram

4.3 Power supply

The power supply: battery.

4.3.1 Battery power supply

- (1) Install the battery into the main unit as described in “4.2”.
- (2) Press the power button to turn on the device and enter the working state.

4.3.2 Battery power charging

Battery is charged by charger.

- (1) Remove the battery from the main unit and connect it to the socket of the charger.
- (2) Insert the AC plug of the charger into the power supply socket.
- (3) When the battery is being charged, the indicator light on the charger turns red. When the battery is fully charged, the indicator light turns green.

Chapter Five User Interface

5.1 Expert mode

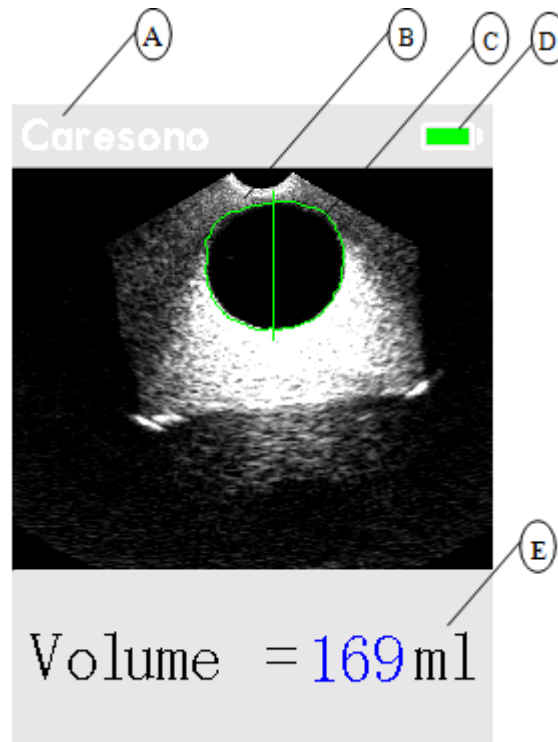

Figure 5-1 PadScan HD 2 expert mode screen

- A: Company logo
- B: Ultrasonic image outlining
- C: Bladder ultrasonic image
- D: Battery status indicator
- E: Bladder volume value

5.2 Easy mode screen

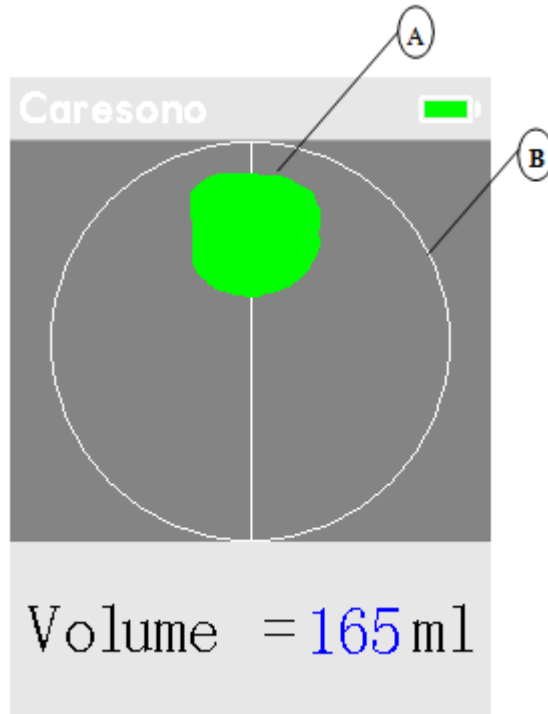

Figure 5-2 PadScan HD 2 easy mode screen

A: Section diagram of the bladder

B: Circle of Easy Mode

5.3 System settings

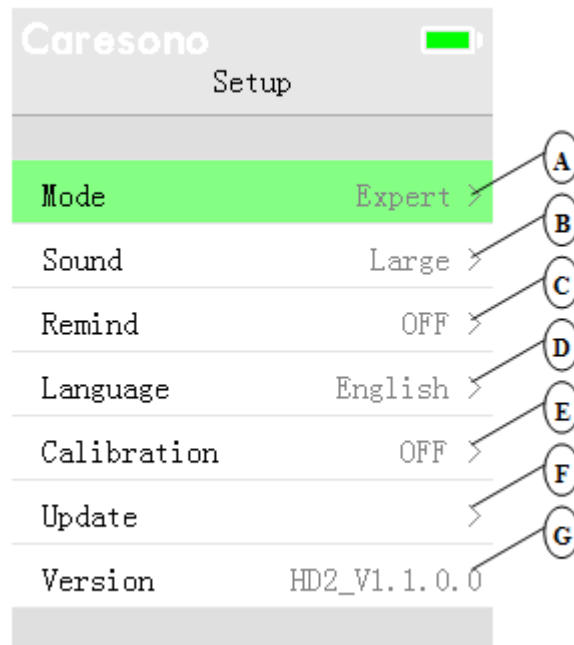

Figure 5-3 PadScan HD 2 system setup

A: Mode selection

B: Sound Volume

C: Remind

D: Language

E: Device Calibration

F: Firmware Update Update

G: Version Display

Chapter Six Operation





6.1 Bladder scanning

Turn on the device and enter the user interface. Coat the hypogastria of the patient and the probe with ultrasonic gel before the scan. Place the probe on the patient's bladder. Press the scan key to start pre-scan and scan.

In the expert mode (shown as figure 5-1), press the scan key on the device, the ultrasonic image of the patient's bladder will be displayed on the screen in real time. After locating the right position of bladder, press the scan key again. Then the image analysis and calculation end, both the ultrasonic image of the bladder and the bladder volume value will be displayed on the screen.

In the easy mode (shown as figure 5-2), press the scan key on the device, the screen displayed real time sectional image of the bladder, Enter the pre-scan, the operator just observe whether the sectional image of the bladder is located in the indicated center of the screen, If not, move the probe to locate the sectional image of bladder in the indicated center. After that move the probe repeatedly to find maximum sectional image of the bladder, press the scan key again. The image analysis and calculation end, then the bladder volume value will be displayed on the screen.

6.2 Store information

HD2 adopts voice record, ultrasonic image and bladder volume value to store the measurement information of the patient. After scanning the bladder, Long press the recording key (approximately 1 seconds), “” on the screen indicates that the device is recording. After record release the recording key to play the record, “” on the screen indicates that the device is playing the record. After that, the information will be stored automatically in the SD card. “” on the screen indicates the device is storing the information. “” will disappear when device finishes storing the information.

Tips:

1. The screen will show the warning as below picture shown if there is no SD card in the device.

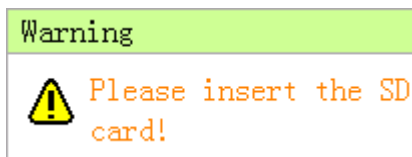

2. After finishing recording, playing and storing, long press the recording key for recording, then the generated BMP, TEX and WAV files will overwrite the previous files.

6.3 Parameter setup

Long press setup key to enter parameter setup interface (as figure 5-3), including 6 menus. The functions are as follows.

6.3.1 Mode selection setup

Enter the parameter setup interface. Expert mode is the default selection, press recording key to select the modes. The two modes are expert mode and easy mode.

6.3.2 Sound volume setup

Enter the parameter setup interface. Press setup key to select the Sound volume setup item. Then press recording key to set the sound volume level, it divides into Max, Medium and Min levels.

6.3.3 Remind setup

Enter the parameter setup interface. Press setup key to select the Remind setup item. Then press recording key to set remind value. When the patient's bladder volume value is higher than the set remind value, the buzzer will alarm. The remind value divides into 4 levels including: OFF, 300,400 and 500.

Note:

1. OFF means that the alarm's function is closed.
2. The level 300 means the patient's bladder volume value is higher than 300ml, the buzzer will alarm, otherwise it won't alarm.
3. The level 400 means the patient's bladder volume value is higher than 400ml, the buzzer will alarm, otherwise it won't alarm.
4. The level 500 means the patient's bladder volume value is higher than 500ml, the buzzer will

alarm, otherwise it won't alarm.

6.3.4 Language setup

Enter the parameter setup interface. Press setup button to select the Language setup item. Then press recording key to select language, the device supports multiple languages; there are English, French, Danish, Swedish, Spanish, Finnish, Portugal, Dutch, Norwegian, German, and Italian.

6.3.5 Device calibration setup

Enter the parameter setup interface. Press setup button to select the Device calibration setup item. Then press recording key to select calibration mode, it divides into two modes; they are Calibration and Normal mode.

6.3.6 Firmware update setup

Enter the parameter setup interface. Press the setup key to select Firmware update setup item. Then press recording key to enter the update interface. Do not turn off the power or pull out the SD card during the update. If there is no SD card in the device nor updating firmware in the SD card, the “No firmware files!” will be displayed on the screen of the device, shown as follows:

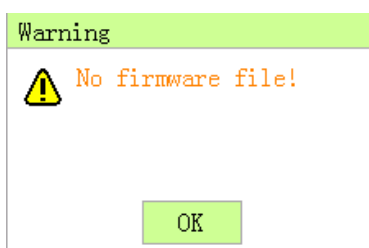

If the update succeeds, the alert box will be displayed on the screen as follows:

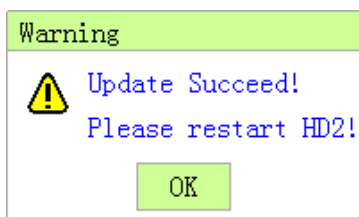

If update fails, the alert box will be displayed on the screen as follows, and do not turn off the power moment, Update the device again until the update is successfully completed.

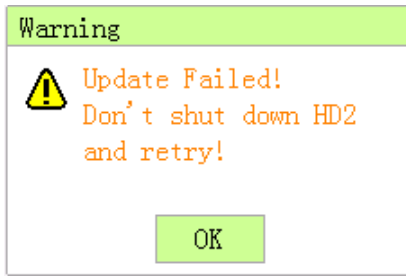

6.3.7 Version number display

Enter the parameter setup interface. Press setup key to display the version number on the screen.

6.4 View patient information

Remove the SD card from the device and insert it to the computer, there is a corresponding folder including ultrasonic images of bladder (BMP format), bladder volume value (TXT format), and record contents (WAV format)

Chapter Seven Cleaning and Maintenance

To ensure that the device functions normally, please perform regular cleaning and maintenance of parts, accessories and probes with mild detergent.

7.1 System cleaning and maintenance

7.1.1 System cleaning

- (1) Turn off the device.
- (2) Remove the battery from the device.
- (3) Use a soft, clean cloth dampened with isopropyl alcohol (or an appropriate hospital cleaning agent), to clean the device's surface.
- (4) Control the time of sponging according to the instructions of the detergents, and the interval time should also meet the clinical requirements.
- (5) Dry the system's surface naturally or dry it with clean cloth according to the instructions of the detergent label.
- (6) Use soft and wet cloths with neutral detergents to clean the fingerprint or other filth on the display screen.

7.1.2 System maintenance

- (1) Operate the system in the environment as specified in "1.5".
- (2) After shutting down the device, wait five minutes before restarting the system.
- (3) When the device is not used for a long time, pack the device and store in the environment as specified in "8.2".

7.2 Probe cleaning and maintenance

Please keep the probe clean to ensure the probe work normally and prolong its service life.

7.2.1 Probe cleaning

(1) Check the probe for signs of damage, such as leaking. If any sign of damage appears, stop using the probe and contact CARESONO for service immediately.

(2) Use a soft cloth dampened with isopropyl alcohol (or an appropriate hospital cleaning agent) to wipe the probe until it is thoroughly cleaned.

7.2.2 Probe maintenance

(1) Must not hit and drop the probe.

(2) It is recommended to only use ultrasound gel which FDA listed or cleared. If the ultrasound gel doesn't qualify, it will damage the probe and stimulate the skin.

(3) Clean the probe each time after using it.

7.3 Battery usage and maintenance

(1) For optimum performance, it is recommended to charge and completely discharge a new battery two to three times before first use.

(2) The battery can be charged and discharged for hundreds of times. When the work time shortens apparently, please replace it with a new one.

(3) Do not use, store and charge the battery near the fire.

(4) Do not make the battery short circuit, protect the battery from damp; do not disassemble the battery; do not drop and hit the battery.

(5) The battery should be charged and discharged every two or three months to prevent the battery from invalidation. **Note:** The full battery which has not been used for a long time will discharge slowly. So you should charge the battery which has not been used for a long time before reusing it.

(6) If the battery is deformed, discolored; getting hot; giving off an unusual odor; appearing any other abnormal phenomena, stop using the battery at once. Remove it from the device or the battery charger and discard the battery according to the waste handling regulations.

7.4 Treating and disposing of products after use

The disposal of the waste product and battery should be accord with the local environmental protection regulations. Or contact with our after-sale service department.

Chapter Eight Transportation and Storage

8.1 Transporting the system

(1) Carefully place the device into the corresponding slot of the carrying case. Do not drop, shake or bang the probe or the device.

(2) After the cover is covered, the container can be moved.

8.2 Transportation and storage conditions

Temperature: -40°C to $+55^{\circ}\text{C}$

Relative humidity: 10% to 80%

Pressure: 50kpa to 106kpa

8.3 Transportation

The label of the packing box for the device meets the requirements of ISO780 Packaging - Pictorial marking for handling of goods. The packing box contains simple shockproof packing, making it suitable for air, railway, highway, or steamship transportation. Keep dry, avoid inversion and collision.

8.4 System storage

- System should be unpacked when storage time exceeds six months. Turn on the device for four hours, and then pack it according to the indication on the box. Do not place any objects on the package, and do not place it against floors, walls, or roof.
- Keep it in a well-ventilated place and keep away from sunlight or caustic gases.

Chapter Night Checking and Troubleshooting

9.1 Checking

- Check if the power supply is functioning properly (the battery is well installed to the device)

9.2 Troubleshooting

NO.	Symptom	Check/Corrective Action(s)
1	When power button pressed, the indicator does not turn on and no signal on the display screen visible.	<ol style="list-style-type: none"> 1. Check whether or not the battery is well installed to the device. 2. Check whether or not the battery is working
2	Screen display shows “snow-like” images or mesh interference appears on the screen.	<ol style="list-style-type: none"> 1. Check the power supply and see whether or not the battery is working properly. 2. Check the surroundings and whether there is the electromagnetic interference.

9.3 Contacting Caresono for support when fault of device unsolved

9.4 Maintenance

- Please perform maintenance in specified departments
- Please contract manufacturers for maintenance information

Chapter Ten Acoustic Output

This section of the User 's manual applies to the overall system including the main unit, probes, accessories and peripherals. This section contains important safety information for operators of the device, pertaining to acoustic output and how to control patient exposure through use of the ALARA (as low as reasonably achievable) principle.

Read this information carefully before using the PadScan HD2 Bladder Scanner.

10.1 Concerns with Bioeffects

Diagnostic ultrasound is recognized as being safe. In fact, there have been no reports of injuries to patients caused by diagnostic ultrasound.

It cannot be stated categorically that ultrasound is 100% safe. Studies have revealed that ultrasound with extremely high intensity is harmful to body tissues.

Diagnostic ultrasound technology has made a great leap forward during the last several years.

This rapid advance has generated concerns about the potential risk of bioeffects when new applications or diagnostic technologies become available.

10.2 Prudent Use Statement

Although there are no confirmed biological effects on patients caused by exposures from present diagnostic ultrasound instruments, the possibility exists that such biological effects may be identified in the future. Thus ultrasound should be used in a prudent manner to provide medical benefit to the patient. High exposure levels and long exposure times should be avoided while acquiring necessary clinical information.

10.3 ALARA Principle (As Low As Reasonably Achievable)

It is required to practice ALARA when using ultrasound energy. Practicing ALARA ensures that the total energy level is controlled below a low enough level at which bioeffects are not generated while diagnostic information is being accumulated. The total energy is controlled by output intensity and total radiation time. The output intensity necessary for examinations differs depending on the patient and the

clinical case.

Not all examinations can be performed with an extremely low level of acoustic energy.

Controlling the acoustic level at an extremely low level leads to low-quality images or insufficient Doppler signals, adversely affecting the reliability of the diagnosis. However, increasing the acoustic power more than necessary does not always contribute to an increase in quality of information required for diagnosis, rather increasing the risk of generating bioeffects.

Users must take responsibility for the safety of patients and utilize ultrasound deliberately. Deliberate use of ultrasound means that output power of ultrasound must be selected based on ALARA.

Additional information regarding the concept of ALARA and the possible bioeffects of Ultrasound is available in a document from the AIUM (American Institute of Ultrasound Medicine) title “Medical Ultrasound Safety”.

Users can not adjust the acoustic output energy of the PadScan HD2 Bladder Scanner. And the output level is below than the levels which were referred in AIUM remarks in 1992 and there were no reported biological effects under the level. However, to minimize exposure, measurements should be kept as short as possible. Refer to the acoustic output section for more information.

10.4 Acoustic Output

10.4.1 Derated Ultrasonic Output Parameters







The ‘derated’ intensity calculations are based on the measured center frequency of the acoustic signal (f_c , MHz) and the current hydrophone to the tested transducer (d , cm) using the derating factor $e^{-.069 \times f_c \times d}$

10.4.2 Limits of Acoustic Output

In accordance with the FDA Track 1 requirements, the derating (or attenuated) approach was incorporated into the FDA Acoustic Output Limits, as listed below. The maximum acoustic output level from any transducer in any operating mode is expected to fall below these limits.







Appendix A: Labeling

HD 2 Main unit labeling

Name	Bladder Scanner		
Safe mode	Type B	Model	PadScan HD 2
Power Consumption	10VA	SN	
Power	DC7.4V \pm 0.5V	 0482	 Type B Applied Part
 Date of Manufacture			
Transducer Model	N3/3.5MHz		 Collect separately from other household waste
 Manufacturer	Caresono Technology Co.,Ltd. 4th Floor, No. 11 Building, Initiating Zone, Instruments and Meters Industry Base, Near Port Industry Zone, Dandong, Liaoning		
	MEQUIPEX Feldstrasse 39, 4813 Altmuenster Austria		

HD 2 Outer Package labeling

 Caresono Technology Co.,Ltd. 4th Floor, NO. 11 Building, Initiating Zone, Instruments and Meters Industry Base, Near Port Industry Zone, Dandong, Liaoning 118009, China Tel: 0086-415-6279782 Fax: 0086-415-3191279 http://www.Inhand.com/en E-mail: Inhand@yahoo.cn

					
Handle with care	Temperature limit	Upwards	Limited layers or storage	Keep dry	Keep away from sunlight

NAME	BLADDER SCANNER
MODEL	Padscan HD 2
G.W./N.W.	1kg/4.25kg
Q.TY	1
DIMS	430X320X245 ³

Storage and transportation condition:	
Temperature:-40°C - +55°C	
Relative humidity range:10%-80%	
Atmospheric pressure range:50KPa-106KPa	

CAUTION

U.S.A.Federal law restricts this device to sale by or on the order of a physician

**MEDICAL
EQUIPMENT
SONT DROP-FRAGILE**

Appendix B: Acoustic Output Report

Acoustic Output Reporting Table for Track 1

Autoscanning Mode

System Model: PadScan HD2

SN:BB/15070005

Application(s): Bladder Imaging & Other

Operating mode: B-Mode

Acoustic Output		MI	ISPTA.3 (mW/cm ²)	ISPPA.3 (W/cm ²)	
Global Maximum Value		0.466	13.78	24.94	
Associated acoustic parameters	P _{r,3} (MPa)	0.872			
	W _o (mW)		3.12	3.12	
	f _c (MHz)	3.50	3.50	3.50	
	Z _{sp} (cm)	4.70		4.70	
	Beam dimensions	X- ₆ (cm)			2.56
		Y- ₆ (cm)			2.30
Other information	PD (μ s)	0.483		0.483	
	PRF (Hz)	2283		2283	
	EDS	Az. (mm)		φ 14	
		Ele. (mm)		φ 14	
Operating control condition	Default setting	✓	✓	✓	

Acoustic Output Reporting Table for Track 1

Autoscanning Mode

System Model: PadScan HD2

SN:BB/15070012

Application(s): Bladder Imaging & Other

Operating mode: B-Mode

Acoustic Output		MI	ISPTA.3 (mW/cm ²)	ISPPA.3 (W/cm ²)	
Global Maximum Value		0.376	10.87	19.42	
Associated acoustic parameters	P _{r,3} (MPa)	0.711			
	W _o (mW)		2.64	2.64	
	f _c (MHz)	3.57	3.57	3.57	
	Z _{sp} (cm)	4.70		4.70	
	Beam dimensions	X- ₆ (cm)			3.01
		Y- ₆ (cm)			2.92
Other information	PD (μ s)	0.491		0.491	
	PRF (Hz)	2283		2283	
	EDS	Az. (mm)		φ 14	
		Ele. (mm)		φ 14	
Operating control condition	Default setting	✓	✓	✓	

Appendix C: Definitions and Symbols

MI	the Mechanical Index
TISscan	the Soft Tissue Thermal Index in an auto-scanning mode
TISnon-scan	the Soft Tissue Thermal Index in a non-auto-scanning mode.
TIB	the Bone Thermal Index.
TIC	the Cranial Thermal Index.
Aaprt	the area of the active aperture (square centimeters).
pr.3	the derated peak rarefractional pressure associated with the transmit pattern giving rise to the value reported under MI (megapascals)
Wo	For TIB and TIC: time average acoustic power at the source, in milliwatts. (Also see the definitions for W_{01} and W_{01x1} that follow.) For TIS scan, $W_o = W_{o1} + W_{o1x1}$ For TIS non-scan, $W_o = W_{o1x1}$
	W_{o1} : For scanning modes and/or scanning components of combinational modes: time average acoustic power at the source, per cm, in milliwatts. This is the acoustic power emitted from the central 1-cm length, in the scan direction, of the aperture corresponding to the scanned pulses.
	W_{o1x1} : For non-scanning modes and/or non-scanning components of combinational modes: time average acoustic power at the source, per cm ² , in milliwatts. This is the acoustic power emitted from the central 1 cm ² of the active non-scanned aperture through which the highest acoustic power is being transmitted.
$W_{.3}(z_1)$	the derated ultrasonic power at axial distance z_1 (milliwatts)
$I_{TA.3}(z_1)$	the derated spatial-peak, temporal-average intensity at axial distance z_1 (milliwatts per square centimeter).
z_1	the axial distance corresponding to the location of $\max[\min(W_{.3}(z), I_{TA.3}(z) \times 1 \text{ cm}^2)]$, where $z = z_{bp}$ (centimeters).
z_{bp}	$1.69\sqrt{A_{aprt}}$ (centimeters).
z_{sp}	For MI, the axial distance at which pr.3 is measured for TIB, the axial distance at which TIB is a maximum (i.e., $z_{sp} = z_{B.3}$) (centimeters).
deq(z)	the equivalent beam diameter as a function of axial distance z , and is equal to $[(4/)(W_o/I_{TA}(z))]^{0.5}$ where $I_{TA}(z)$ is the temporal-average intensity as a function of z (centimeters).
fc	is the center frequency (MHz). For MI, fc is the center frequency associated with the transmit pattern giving rise to the maximum reported value of MI. For TI, for combined modes involving transmit patterns of unequal center frequency, fc is defined as the overall range of center frequencies of the respective transmit patterns.
Dim. of Aaprt	the active aperture dimensions for the azimuthal and elevational planes (centimeters).
PD	the pulse duration (microseconds) associated with the transmit pattern giving rise to the reported value of MI.

PRF	the pulse repetition frequency associated with the transmit pattern giving rise to the reported value of MI (Hz).
$p_r@PII_{max}$	the peak rarefactional pressure at the point where the free field, spatial-peak pulse intensity integral is a maximum (megapascals). See Section 6.2.4.1 of the Output Display Standard, entitled "Measurement Methodology for Mechanical and Thermal Indices".
$d_{eq}@PII_{max}$	the equivalent beam diameter at the point where the free field, spatial-peak pulse intensity integral is a maximum (centimeters). See Section 6.2.5.1 of the Output Display Standard, entitled "Measurement Methodology for Mechanical and Thermal Indices".
FL	the focal length, or azimuthal and elevational lengths, if different (centimeters).
$I_{PA3}@MI_{max}$	the derated pulse average intensity at the point of maximum reported MI (Watts per square centimeter).

p_-	MPa	The Peak Rarefactional Acoustic Pressure is the maximum of the modulus of the negative instantaneous acoustic pressure expressed as a positive number.
ISPTA	mW/cm ²	The maximum value of the temporal average derived intensity in an acoustic field. For systems in combined operating mode, the time interval over which the temporal average is taken is sufficient to include any period during which scanning may not be taking place.
System settings ^a		User selectable system settings which may include Application, SV and Focal Length.
I_p	mm	This is the distance from the transducer output face to the point of maximum pulse-pressure-squared integral (or max mean square acoustic pressure for continuous pressure for CW)
$w_{pb6} ()$	mm	This is the -6dB pulse beam width in the beam axis (X) at the point of max pulse-pressure-squared integral (or max mean square acoustic pressure for continuous pressure for CW). If the beam widths in X and Y differ than less than 10%, there is no need to specify both. For scanning modes, the beam-widths shall correspond to the central scan line only.
$w_{pb6} (\perp)$	mm	This is the -6dB pulse beam width in the elevational axis (Y) at the point of max pulse-pressure-squared integral (or max mean square acoustic pressure for continuous pressure for CW). If the beam widths in X and Y differ than less than 10%, there is no need to specify both. For scanning modes, the beam-widths shall correspond to the central scan line only.
Prr	kHz	Pulse Repetition Rate is the rate of successive pulses or tone bursts and applies to single element non-scanning systems and automatic scanning systems.
Srr	Hz	Scan Repetition Rate is the rate of the same identical point of successive frames, sectors, or scans and applies to automatic scanning systems (modes) only.
Output beam	mm	Output beam dimensions are the dimensions of the ultrasound

dimensions ^b		beam (-6dB pulse beam width) in a specified direction normal to the beam alignment axis and at the transducer output face. In scanning modes, these shall refer to the center scan line only.
Fawf	MHz	The Arithmetic-mean Acoustic Working Frequency is the arithmetic mean of the frequencies f1 and f2 at which the amplitude of the spectrum of the acoustic signal first becomes 3dB lower than the peak amplitude.
APF ^c	%	Acoustic Power-up Fraction is the ratio of the peak rarefactional acoustic pressure when the system is in Power-up mode to the maximum value of the peak rarefactional acoustic pressure for any system settings of a specified mode of operation. This ratio is determined from measurements made at the position which yields the maximum pulse-pressure-squared integral (or maximum mean square acoustic pressure for CW)
AIF ^d	%	Acoustic Power-up Fraction is the ratio of the peak rarefactional acoustic pressure when the system is in Initialization mode to the maximum value of the peak rarefactional acoustic pressure for any system settings of a specified mode of operation. This ratio is determined from measurements made at the position which yields the maximum pulse-pressure-squared integral (or maximum mean square acoustic pressure for CW)
Maximum power ^e	mW	This is the Maximum Temporal Average power output. For scanning modes, this shall be the total power output of all the acoustic pulses.
Iob	mW/ cm ²	Output Beam Intensity is the temporal-average power output divided by the output beam area
Power-up mode		With the probe connected cycle power on the system. Write down the mode to which the system powers up. Usually, it is "B" mode.
Initialization mode		Write down "N/A" where it denotes "system settings do not change on new patient entry"
Acoustic output freeze		Write down "YES" if the system is supplied with an output freeze facility.
I _t	mm	Transducer to Transducer output face distance is the distance along the beam alignment axis between the surface containing the active face of the transducer or elements and the transducer output face (usually the lens thickness)
I _s	mm	Transducer Standoff distance is the shortest distance between the transducer output face and the patient entry plane. The term "contact" is used to connate direct contact between the transducer output face and the patient.