

Spectra Essential

User manual

Before use, please read this document.
Kinetec reserves the right to effect technical modifications.

EN



467896354 – 07-2014
Série 1 – 2 – 3 - 4
Notice Originale



Distributed by :

kinetec
USA

Kinetec USA
W225N16708 Cedar Park Ct
Jackson, WI 53037
USA



262-677-1248



262-677-1314



contact@kinetecusa.com



www.kinetecusa.com

Manufactured by:

kinetec

Kinetec SAS
Zone Industrielle de Tournes
Rue Maurice Périn
F-08090 Tournes
France



+33 (0)3 24 29 85 05



+33 (0)3 24 33 51 05



contact@kinetec.fr



www.kinetec.fr

Summary

	Page
• Definition _____	2
• Warning and safety instructions _____	2
• Compliance _____	3
• Unpacking and packing _____	3
• Installing the device _____	3
• Description _____	4
• Electrical connection _____	5
• Procedure to start the machine _____	5
• Using the hand control	
- Changing the display language _____	5
- START/STOP/REVERSE function _____	5
- Procedure to stop the machine _____	5
- Locking-Unlocking the hand control setting _____	6
- Setting the movement parameters _____	6
- Possible values for each parameter _____	6
• Using the Plastic Comfort Case kit _____	7
• Using the Kinetec Patient Pad kit _____	7
• Setting up the patient _____	8
• Options _____	8
• Product information	
- Maintenance _____	9
- Troubleshooting guide _____	9
- Cleaning _____	9
- Disposal and recycling _____	9
- Technical specifications _____	10
- Symbols used _____	10
- Warranty _____	10
- Guidance and manufacturer's declaration _____	11

Definition

The device KINETEC® *Spectra Essential* is a PASSIVE KNEE mobilisation device enabling extension and flexion movements from -10° to 120°.

Indications

- Arthroplasties of the knee and hip joints.
- Osteosynthesised femoral or tibial fractures.
- Patellar fractures.
- Arthrolysis and palliative surgery (cartilage lesions, removal of osteomas, etc.).
- Osteotomies of the pelvis or femur.
- Ligament repairs (LCI, LCE, LLI, LLE).
- Freeing the knee extensor mechanism (Judet's operation).
- Synovectomies, Meniscectomies, Patellectomies, Arthroscopies.

Clinical Benefits

- Effectively breaks the vicious circle: trauma, immobility, effusion and atrophy.
- Prevents joint stiffness of the knee and hip.
- Speeds the recovery of post-operative range of motion.
- Maintains the quality of the joint surface.
- Promotes joint cartilage healing.
- Prevents venous thrombosis.
- Provides immediate post-operative continuous passive motion.
- Reduces hospitalization time.
- Reduces the need for pain medication

Contraindications

Rheumatoid arthritis in the inflammatory phase, gout, algodystrophy in the inflammatory phase (hyper painful), para-osteo-arthroplasty, unhealed infected wounds, established phlebitis, bone cancer, myositis ossificans of the quadriceps, arthrodesis of the hip, infectious arthritis, deformed joint surfaces, paralysed limbs (atonic or spastic), non-stabilised fractures.

The machine is not suitable for patients over 1.95 m (6'7") or under 1.45m (4'7") tall.

Warning and safety instructions



- WARNING: The machine must be installed and commissioned according to the information provided in this manual.
- WARNING: If you need any assistance in the assembly, use or maintenance of the device, please contact your Kinetec distributor.
- WARNING: The practitioner determines the protocol and ensures its proper implementation (settings, session duration and frequency of use).
- WARNING: Run a cycle with the device unloaded before installing the patient on the machine.
- WARNING: For optimum safety, always give the hand control to the patient before starting the system. The patient must know the start/stop/reverse function on the hand control, see page 5.
- WARNING: To avoid the parameters being changed, lock the machine's hand control before giving it to the patient, see page 6.
- WARNING: Danger, risk of explosion: Do not use the machine with anaesthetic gas or in an environment that is rich in oxygen.
- WARNING: For Type B Class I devices, and to avoid all risks of electric shock, the machine should only be connected to a power supply that has protective earthing, see page 5.
- WARNING: Before using this machine, always check that the electrical socket is in good condition and is suitable for the splint power supply cord. Only use the original cable supplied with the machine. Check that the cables remain free around the device so that they do not get damaged.
- WARNING: Before using this machine, always check that the machine is not damaged, in particular the protective housings.
- WARNING: In case of electromagnetic interference with other devices move the device.
- WARNING: Please do not touch the fixed or moving parts while the unit is running: pinching or crushing risk. Keep children and pets away from the machine.
- WARNING: Modifying the machine in any way is strictly forbidden.
- WARNING: Always check the motion parameters displayed on the hand control before starting the device.
- WARNING: Only the accessories, spare parts and supplies described in this manual should be used with this machine.
- WARNING: Do not connect the device to other devices not described in this manual.
- WARNING: If unforeseen events or malfunctions occur, please contact your KINETEC distributor.
- WARNING: Wireless communications devices, such as domestic wireless devices in networks, mobile phones, wireless telephones and their base stations and walkie-talkies, may affect the machine. You are recommended to keep at least a distance *d* between these devices and the machine. See the table on page 12.

Compliance:

The device KINETEC® Spectra Essential complies with the standards of Directive 93/42/EEC, and bears the EC mark.

The device KINETEC® Spectra Essential complies with the standards in force (IEC 60601-1-2) concerning the electromagnetic compatibility of medical devices and IEC 60601-1 concerning electrical safety.

The device KINETEC® Spectra Essential meets the requirements of the Machinery Directive No. 2006/42/EC.

Unpacking and packing

Unpacking

When you unpack the machine, don't forget that you may need to pack it up again. We recommend that you keep the packaging materials, boxes and plastic bags.

Recommendations for plastic bags: do not put them over the head as there is a risk of suffocation, and keep them out of the reach of children. Be careful with small-sized pieces: they could be swallowed by a child.

Be careful with cords and cables: risk of strangulation.

Before using your machine you must move the foot plate into its working position. (See page 8).

Your machine is ready to be connected to the power supply. (See page 5).

Packing

To prevent any problems when the machine is transported, only pack it using its original packaging.

- Set the leg support to 42cm
- Stop the unit at 5° of flexion.
- Move the foot plate back into its packing position.

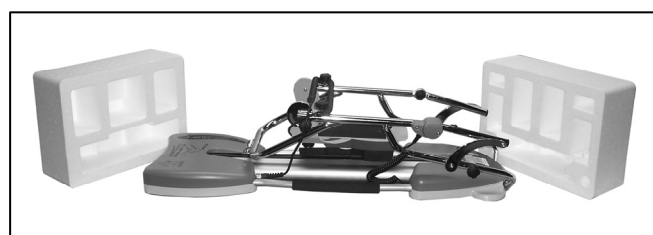
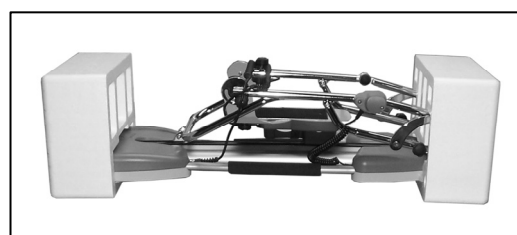

Installing the device

The device KINETEC® Spectra Essential machine is designed to be used in hospitals, clinics, doctors' offices or in private homes (rental).

The machine must be installed on a flat surface that is wide enough to accommodate the entire device plus the other leg.

We recommend using the machine with a physiotherapy table, a healthcare bed, a bed or a bench. We do not recommend the use of an air mattress.

Description

The device KINETEC® Spectra Essential machine consists of the following components:

- 1 • Lower limb support.
- 2 • Thigh support.
- 3 • Articulated foot plate and hand control location for transport.
- 4 • Hand control.
- 5 • Thigh support setting lock.
- 6 • Lower limb support setting lock.
- 7 • Foot plate position setting lock.
- 8 • Transport handle.
- 9 • ON/OFF switch and fuses.

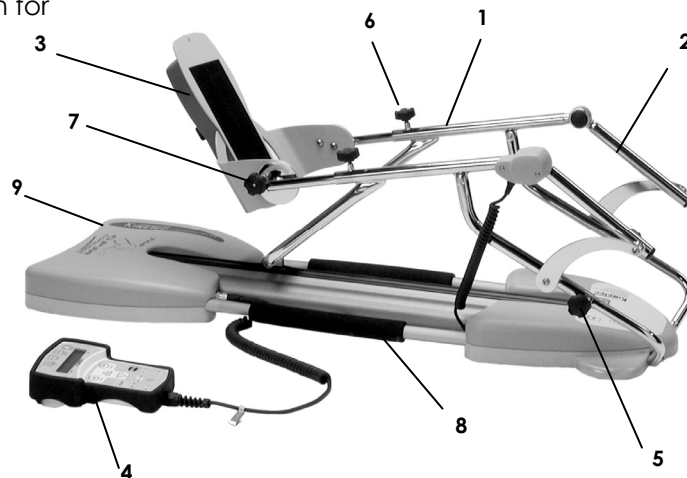

- 10 • Liquid-crystal display (2 lines of 16 characters).
- 11 • Increase / decrease keys.
- 12 • EXTENSION setting key.
- 13 • FLEXION setting key.
- 14 • STOP key.
- 15 • START key.
- 16 • PAUSE key.
- 17 • SPEED key.

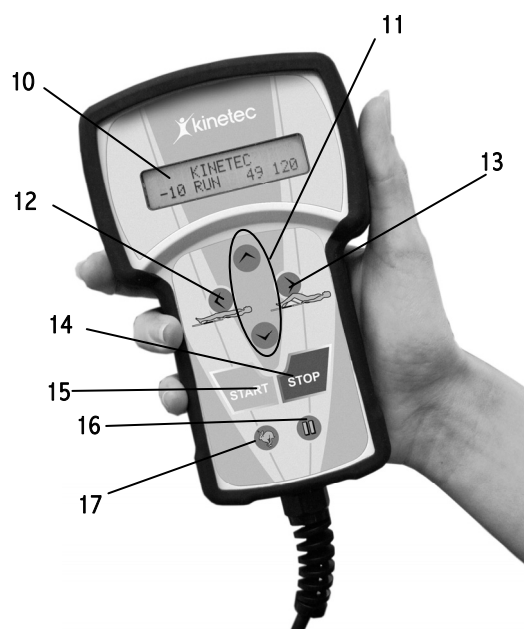

Display Details:

- A • 16-character line, used to display various messages when starting up the machine; then the display does not change while the machine is being used.
- B • 16-character line, used to display various messages when starting up the machine; then it displays the operational parameters.
- C • 3-character area showing the extension limit.
- D • 4-character area showing various messages: RUN, STOP, EXT, FLEX.
- E • 3-character area showing the real-time angle of the knee; this value changes with the current movement.
- F • 3-character area showing the flexion limit.

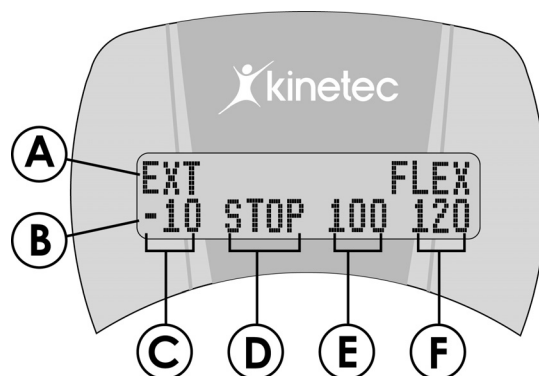

Electrical connection: safety first.

2 versions of electrical protection are available for the device KINETEC® Spectra Essential machine. The identification label shows which version a machine is equipped with:

Type BF, Class II devices,

for home use, bear the following symbols:

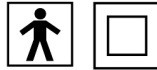

Type B, Class I devices,

for use in a professional environment, bear the following symbols:



See page 10 for the meaning of the symbols.

Before connecting the device to the power supply, check that the mains voltage matches that shown on the identification plate (100-240V~ 50/60Hz).

Connect the hand control (4).

Connect the power supply cable (18).

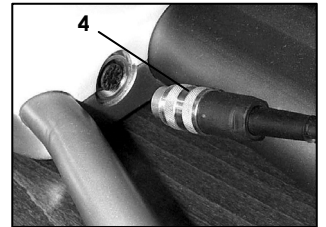
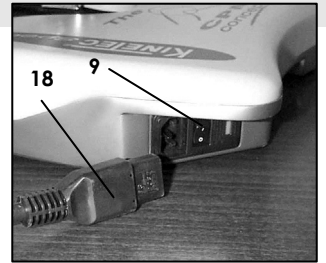

IMPORTANT

For Type B Class I devices, and to avoid all risks of electric shock, the machine should only be connected to a power supply that has protective earthing.

To connect the power supply, only use the original cable supplied with the machine.

Check that the cables remain free around the device so that they do not get damaged.

Check that the machine is not damaged, in particular the protective housings.

Procedure to start the machine

Press the ON / OFF switch (9).

The display comes on, the machine carries out a self-test, and then the display shows:

Your device KINETEC® Spectra Essential is ready to be used.

EXT	FLEX
30	STOP 15 70

Changing the display language

Beginning	Keys to press	Display	Remarks
Switch the unit ON		KINETEC 40 STOP 50 110	Check if the hand control is not locked (See page 6).
Press simultaneously on the 2 keys	and	LANGUAGE ENGLISH	The display indicates the language selected.
To change the language	Or	LANGUAGE FRENCH	The French language is selected. Available languages: English, French, German, Italian and Spanish.
To confirm the new language		OK SWITCH ON/OFF	Switch the machine off and then on again to apply the changed display language.

START / STOP / REVERSE function

As with all KINETEC systems, KINETEC® Spectra Essential machines are equipped with a START/STOP/REVERSE function.

Press the key of the hand control. The movement stops,

Press the key of the hand control. The movement starts in the opposite direction.

CAUTION

For optimum safety, always give the hand control to the patient before starting the system.

Procedure to stop the machine:

To stop the machine's movement: press the key

To switch the unit off: press the ON / OFF switch (9) (see page 5)

Locking the hand control setting

The hand control allows the patient to control the machine as appropriate.

Simultaneously press the  and  keys to lock the hand control,

The display reads **LOCK**, you cannot change the parameters; if you try the message **LOCK** appears. To unlock the hand control, simultaneously press the same keys. The display will show **UNLOCK**.

We recommend that you lock the hand control when you give it to the patient.

Note: the hand control locking is preserved when you switch the unit ON/OFF.

Setting the movement parameters

Select the parameter to be set:

Extension limit  or flexion limit  or speed  or

pause  at the extension or flexion limit; the setting to change will flash.

Press the  or  buttons to modify the setting; the new setting will flash.

To confirm the new setting, press another function button or wait approximately 5 seconds for automatic confirmation.

Movement parameters can be set either when the machine is stopped or when it is in operation.

Note: pressing the  button repeatedly allows you to select pausing at the extension or flexion limit.

Possible values for each parameter:

	Possible values	Default setting
• Extension limit	-10 to 115°	30°
• Flexion limit	-5° to 120°	70°
• Speed	1 to 5 (from 45° to 155° per minute)	2
• Extension pause	0 to 900 seconds (15 minutes)	0
• Flexion pause	0 to 900 seconds (15 minutes)	0

Using the Plastic Comfort Case kit

Plastic Comfort Cases are specially designed to improve comfort and hygiene for the patient. They have clips, fixed directly on the tubes of the machine's thigh and lower limb support segments, and straps with protection stops to precisely and quickly adjust to the patient's leg dimensions.

Cleaning

To ensure optimal hygiene, clean the supports after each patient use.

Use a DISINFECTANT product (alcohol-free or <5% alcohol solution) in spray (plastic cases and metal components).

**We recommend changing the cases every 500 hours of operation.
(See the Maintenance chapter for the running time counter).**

Replacement parts

- a 4670024048 Complete foot support
 - b 4635010561 Foot support strap kit
 - c 4635010157 Tibia case only
 - d 4670024329 Tibia case with straps
 - e 4635010165 Femur case only
 - f 4670024337 Femur case with straps
 - g 4650001876 Single strap
- Part number to order a complete kit:
- fastening with clips: 4670024345
 - fastening without clips: 4670023701 (if your machine is not fitted with clips).

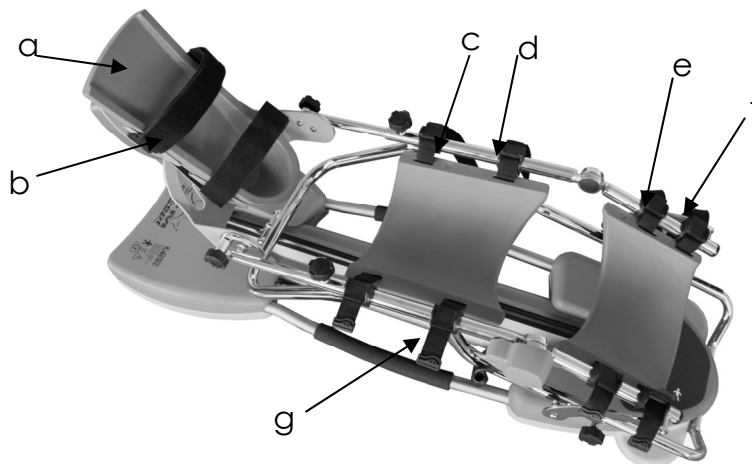

Using the Kinetec Patient Pad kit

The KINETEC® Patient Pad Kit is designed for rapid fitting, optimal hygiene and maximum patient comfort.

- For using and positioning the straps, please refer to here under. Make sure that the self-adhesive parts (19) are visible.
- Place the sponge side next to the skin.

**FOR OPTIMAL HYGIENE, A NEW SET OF PADS SHOULD BE USED FOR EACH PATIENT.
Each cover is provided with a label to record the patient's name**

CLEANING:

- Sterilizing the pads (if necessary): Sterilize at 134 °C for 18 minutes.
- Disinfecting the straps: Wash at 30°C, using a disinfectant solution during the rinse cycle. Example of product that can be used: Solution "Bac linge" at 0.125 % or "Souplanios" at 0.125% from ANIOS Laboratories. A complete list of distributors in your country is available on request.

The device KINETEC® Spectra is delivered with a complete set, comprising:

- 4 straps (4650001107)
- 1 foot support (4650001420)
- 1 cover (4650001090)

Part number to order the complete set: 4650001868

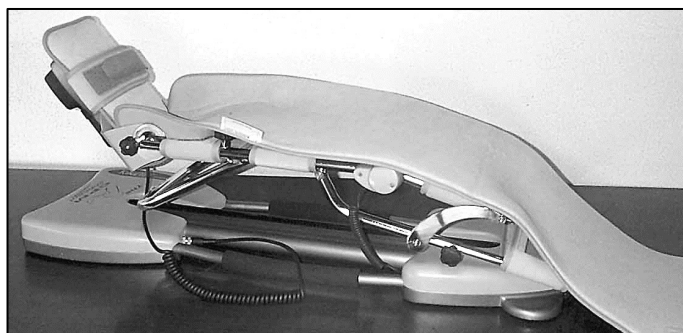
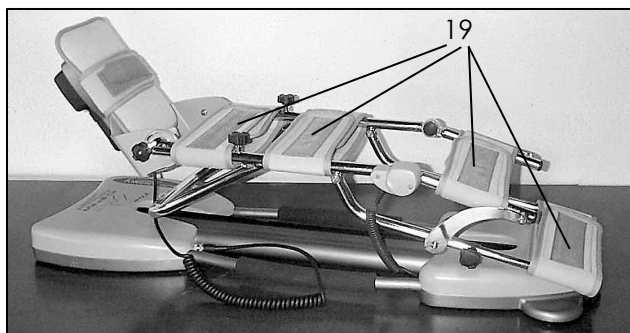

Setting up the patient

See page 3, Installing the Device chapter, for the positioning conditions.

Place the unit in a position that will be comfortable for the patient.

- Measure the length of the patient's femur in cm or inches (L); adjust the thigh support to this measurement using knobs (5).
- Install the patient on the machine.
- Bring the foot plate (3) into contact with the patient's foot, then tighten both buttons (6).
- Adjust the plantar flexion (40°) or the dorsal flexion (30°) of the foot, with the knobs (7).
- Adjust the internal (30°) or external (30°) flexion of the foot, with the knob (20).

CAUTION

Adjust the axis of the patient's hip (21) with the "THEORETICAL" axis of rotation (22) of the unit, and the axis of the patient's knee (23) with the axis of articulation (24) of the unit.

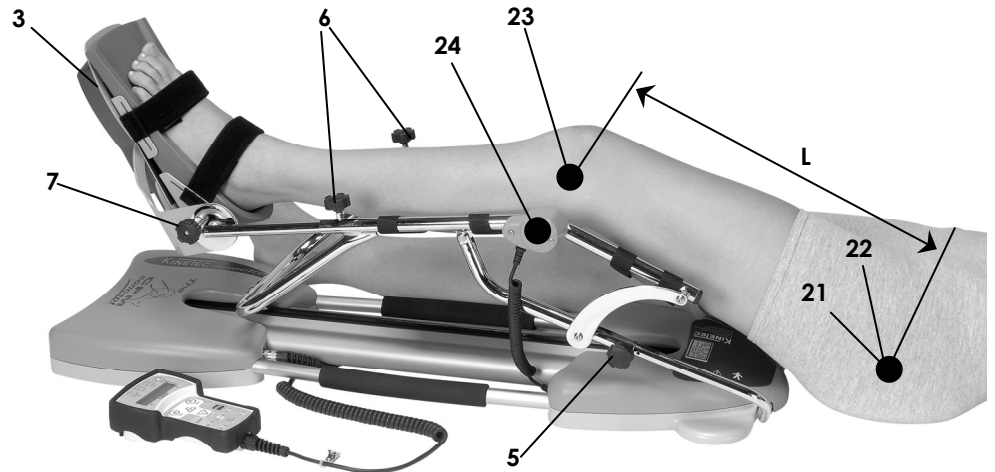
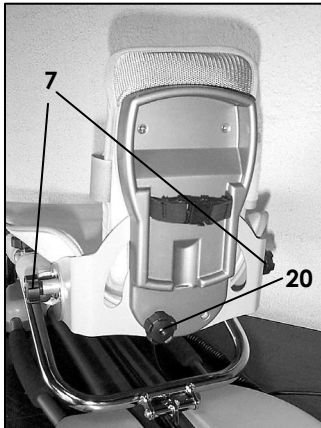

Options



Trolley for all CPM
Part number to order:
4655001053



Cart for bed use
Part number to order:
4665003297



Seat adaptor
Part number to order:
4670024098



Transport box
Part number to order:
4640001927



Paediatric foot plate
Part number to order:
4670023777

Maintenance

After 2,000 hours of operation, or once a year, the device KINETEC® Spectra Essential requires lubrication and maintenance operations (lubrication of the joints, pointer stops and ball screws). The need for maintenance is indicated by display of the message **SERVICE TIME Mx** when the system is switched on.



Despite this indication, you can continue to use your machine by pressing **[START]**, but you should contact your nearest KINETEC technician to have the maintenance operations carried out as soon as possible.

An after-sales service inspection sheet and the technical catalogue are available on request from your KINETEC distributor.

WARNING: Before using this machine, always check that the electrical socket is in good condition and is suitable for the splint power supply cord. Only use the original cable supplied with the machine. Check that the cables remain free around the device so that they do not get damaged.

WARNING: Before using this machine, always check that the machine is not damaged, in particular the protective housings.

When the machine is no longer in working condition, please return it to us, together with its accessories, for destruction.

A motor running time counter is available by simultaneously pressing keys  and  ; the displays shows **RESET TIME 215H** (this is an example).

This counter can be reset by pressing the key .

Troubleshooting guide

A spare parts list and technical catalogue are available on request from your KINETEC distributor.

If, after connecting the power supply cable to the power supply and switching on the machine:

- The display does not indicate any information:
 - Check that the electrical socket is live using another device or voltmeter.
 - Replace the fuse(s) (25) of the connector with fuses of the same type and calibre: 2 fuses T 750 mA 250V (6.3 x 32) (KINETEC order: 4610007434).
 - Check that the hand control is connected properly.
 - If the display still does not indicate any information, contact your nearest KINETEC technician.
- Your machine does not work and the display indicates **50 STOP 25 115**. Press **[START]** again. If your machine still does not work, contact your nearest KINETEC technician.
- Your machine does not work and the display indicates:
 - "SERVICE D1": angle measurement function failure,
 - or "SERVICE D2": no movement,
 - or "SERVICE D3": abnormal consumption,
 - or "PUSH STOP/START": power failure or disconnected motor.switch the machine off then on, contact your nearest KINETEC technician if the same message is displayed



Cleaning

Before carrying out any cleaning operation, SWITCH OFF the unit and disconnect the power supply. In order to ensure optimal hygiene, you are advised to clean the machine for each new patient.

Cleaning should be carried out in the environmental conditions specified in the "Technical Specifications" section below.

Use a DISINFECTANT product (alcohol-free or <5% alcohol solution) in spray.

In order to ensure optimal hygiene, you are advised to clean the covers for each new patient. All the consumables enable hazard-free disposal.

Disposal and recycling

- a • Packaging:** The packaging must be separated into plastic and paper / cardboard components and taken to special recycling sites.
- b • Kinetec patient pad kit:** Clean with a disinfectant product then take it to special recycling sites.
- c • Unit:** It contains electronic components, cables, aluminium, steel and plastic parts. When the machine is no longer operational, disassemble it, separate it into different types of material and take these to authorised recycling centres or return the machine to Kinetec for destruction. Or contact the local authorities to determine the appropriate method of disposal for parts and accessories that are potentially hazardous to the environment.

Technical specifications

Product:

Lifespan of the machine:	12 years
Weight:	12Kg (26 pounds)
Splint dimensions:	95cm (37 inches) x 33cm (13 inches) x 33cm (13 inches)
Angular limits:	-10° to 120°
Speeds:	from 45 to 155° per minute
Patient sizes:	Full leg: 71 to 99 cm (28 to 39 inches) Tibia: 38 to 53 cm (15 to 21 inches) Femur: 33 to 46 cm (13 to 18 inches)
Maximum weight of the user:	135 kg (297 pounds)
Acoustic pressure:	<70dB























Electricity:

Power supply:	100-240V~
Frequency:	50-60 Hz
Power consumption:	50 VA
Class:	Device of Type BF Class II or Type B Class I
Protection classification:	IP 20 (Protected against solid objects greater than 12.5mm, but not protected against liquids)
Fuse:	T 750mA 250V 6.3 x 32mm (Kinetec order: 4610007434)

Environment:

Storage/transport conditions:	Temperature: -25 to 70°C / -13 to 158°F. Relative humidity: up to 93% without condensation.
Operating conditions:	Temperature: 5 to 40°C / 41 to 104°F. Relative humidity: 15% to 93% without condensation. Atmospheric pressure: 700 hPa to 1060 hPa.

Symbols used

	Warning or CAUTION (consult the accompanying documentation)		Speed		Flexion limit
	STOP (power off)		Pause		Extension limit
	ON (power on)		Increase		Start movement
	Right way up when box is stored		Decrease		Stop movement
	Contains electric and electronic components; do not throw away with household refuse.		Temperature Limit during storage or transport		Alternating current
	Follow the instructions for use		Fragile		Keep dry during storage or transport
	Follow the instructions for use		Class II device		
	TYPE BF device (protection against electric shocks)		TYPE B device (protection against electric shocks)		

Warranty

The KINETEC warranty is strictly limited to the replacement, free of charge, or to factory repairs of part(s) recognised as defective.

KINETEC guarantees its continuous passive motion systems for 2 years against all defects of manufacture from the date of purchase by the consumer.

KINETEC is the only organization able to assess the application of the warranty to its systems.

The warranty will be considered null and void if the device has been used abnormally or under conditions of use other than those indicated in the user's manual.

The warranty will also be considered null and void in the event of deterioration or an accident due to negligence, inappropriate surveillance or inappropriate maintenance, or due to transformation of the equipment or an attempt to repair the equipment.

Guidance and manufacturer's declaration

Guidance and manufacturer's declaration - Electromagnetic emissions

The device KINETEC® SPECTRA Essential is intended for use in the electromagnetic environment specified below. The customer or the user of the device KINETEC® SPECTRA Essential should ensure that it is used in such an environment.

Emissions test	Compliance	Electromagnetic environment – guidance
Radio frequency emissions CISPR 11	Group 1	The device KINETEC® SPECTRA Essential uses RF energy only for its internal function. Therefore, its RF emissions are very low and are not likely to cause any interference in nearby electronic equipment.
Radio frequency emissions - CISPR 11	Class B	The device KINETEC® SPECTRA Essential is suitable for use in all establishments including domestic establishments and those directly connected to the public low-voltage power supply network that supplies buildings used for domestic purposes.
Harmonic emissions - IEC 61000-3-2	Class A	
Voltage fluctuations / Flicker emissions - IEC 61000-3-3	Complies	

Guidance and manufacturer's declaration - Electromagnetic immunity

The device KINETEC® SPECTRA Essential is intended for use in the electromagnetic environment specified below. The customer or the user of the device KINETEC® SPECTRA Essential should ensure that it is used in such an environment.

Immunity test	IEC 60601 Test level	Compliance level	Electromagnetic environment – guidance
Electrostatic discharge (ESD) IEC 61000-4-2	±2 kV, ±4 kV, ±6 kV contact ±2 kV, ±4 kV, ±8 kV air	±2 kV, ±4 kV, ±6 kV contact ±2 kV, ±4 kV, ±8 kV air	Floors should be wood, concrete or ceramic tile. If floors are covered with synthetic material, the relative humidity should be at least 30%.
Electrical fast transient / burst IEC 61000-4-4	±2 kV for power supply lines	±2 kV for power supply lines	Mains power quality should be that of a typical commercial or hospital environment.
Surge IEC 61000-4-5	±0,5 kV, ±1 kV between lines ±0.5 kV, ±1 kV, ±2 kV between line and earth	±0,5 kV, ±1 kV between lines ±0.5 kV, ±1 kV, ±2 kV between line and earth	Mains power quality should be that of a typical commercial or hospital environment.
Voltage interruptions IEC 61000-4-11	< 5% U_T (>95% dip in U_T) for 5 seconds	< 5% U_T (>95% dip in U_T) for 5 seconds	When the interruption occurs, the device KINETEC® SPECTRA Essential is reset. After turning on, push START to begin the session.
Voltage dips and voltage variations on power supply input lines IEC 61000-4-11	< 5% U_T (>95% dip in U_T) for 0.5 cycle 40% U_T (60% dip in U_T) for 5 cycles 70% U_T (30% dip in U_T) for 25 cycles	< 5% U_T (>95% dip in U_T) for 0.5 cycle 40% U_T (60% dip in U_T) for 5 cycles 70% U_T (30% dip in U_T) for 25 cycles	Mains power quality should be that of a typical commercial or hospital environment. If the user of the device KINETEC® SPECTRA Essential requires continued operation during power supply interruptions, we recommend powering the device KINETEC® SPECTRA Essential using an uninterruptible power supply or a battery.
Power frequency (50/60 Hz) magnetic field - EC 61000-4-8	3A/m	3A/m	Power frequency magnetic fields should be at levels characteristic of a typical location in a typical commercial or hospital environment.

NOTE: U_T is the AC mains voltage prior to application of the test level.

Guidance and manufacturer's declaration

Guidance and manufacturer's declaration - Electromagnetic immunity

The device KINETEC® SPECTRA Essential is intended for use in the electromagnetic environment specified below. The customer or the user of the device KINETEC® SPECTRA Essential should ensure that it is used in such an environment.

Immunity test	Test level according to EIC 60601	Compliance level	Electromagnetic environment – guidance
Conducted RF interference IEC 61000-4-6	3 V _{eff} from 150 kHz to 80 MHz	3 V	Mobile and portable RF communication devices should not be used closer to any part of the device KINETEC® SPECTRA Essential machine, including its cables, than the recommended separation distance, calculated based on the equation applicable to the emitter's frequency. Recommended separation distance $d = 1.2 \sqrt{P}$
Radiated RF interference IEC 61000-4-3	3 V/m from 80 MHz to 2.5 GHz	3 V/m	$d = 1.2 \sqrt{P}$ from 80 MHz to 800 MHz $d = 2.3 \sqrt{P}$ from 800 MHz to 2.5 GHz where P is the emitter's maximum output power characteristic in watts (W), according to the emitter's manufacturer, and d is the recommended separation distance in metres (m). The field intensities of fixed RF emitters, determined by an on-site electromagnetic investigation ^a , should be below the compliance level in each frequency range ^b . There may be interference near appliances bearing the following symbol: 

NOTE 1 At 80 and 800 MHz, the highest frequency range is applicable.

NOTE 2 These directives cannot be applied in every situation. Electromagnetic propagation is affected by absorption and reflection by structures, objects and people.

^a The field intensity of fixed emitters such as base stations for radio-telephones (cellular/cordless) and land mobile radios, amateur radio, AM/FM radio broadcasts and TV broadcasts cannot be predicted exactly in theory. To evaluate the electromagnetic environment due to fixed RF emitters, an on-site electromagnetic investigation should be considered. If the field intensity measured where the device KINETEC® SPECTRA Essential machine is used exceeds the aforementioned applicable RF compliance level, the device KINETEC® SPECTRA Essential machine should be monitored to check that it is working normally. If abnormal results are observed, additional measures may be necessary, such as reorienting or repositioning the device KINETEC® SPECTRA Essential.

^b Over the frequency range 150 kHz to 80MHz, field intensities should be less than 3V/m.

Recommended separation distances between mobile and portable RF communication devices and the device KINETEC® SPECTRA Essential machine

The device KINETEC® SPECTRA Essential machine is designed to be used in an electromagnetic environment in which radiated RF interference is controlled. The customer or user of the device KINETEC® SPECTRA Essential machine can help prevent electromagnetic interference by maintaining a minimum distance between mobile and portable RF communication devices (emitters) and the device KINETEC® SPECTRA Essential machine, as recommended below, according to the communication device's maximum output power.

Maximum assigned output power for the emitter W	Separation distance according to the emitter's frequency m		
	from 150 kHz to 80 MHz $d = 1.2 \sqrt{P}$	80 MHz to 800 MHz $d = 1.2 \sqrt{P}$	from 800 MHz to 2.5 GHz $d = 2.3 \sqrt{P}$
0.01	0.12	0.12	0.23
0.1	0.38	0.38	0.73
1	1.2	1.2	2.3
10	3.8	3.8	7.3
100	12	12	23

For emitters whose assigned maximum emitted power is not given above, the recommended separation distance d in metres (m) can be estimated using the equation applicable to the emitter frequency, where P is the emitter's maximum emission power characteristic in watts (W), according to the latter's manufacturer.

NOTE 1 At 80 and 800 MHz, the separation distance for the highest frequency range is applicable.

NOTE 2 These directives cannot be applied in every situation. Electromagnetic propagation is affected by absorption and reflection by structures, objects and people.

Distributed by :

kinetec
USA

Kinetec USA
W225N16708 Cedar Park Ct
Jackson, WI 53037
USA

 262-677-1248

 262-677-1314

 contact@kinetecusa.com

 www.kinetecusa.com

Manufactured by:

kinetec

Kinetec SAS
Zone Industrielle de Tournes
Rue Maurice Périn
F-08090 Tournes
France

 +33 (0)3 24 29 85 05

 +33 (0)3 24 33 51 05

 contact@kinetec.fr

 www.kinetec.fr