

Best-fit products by medical area of application

Primary care



seca mBCA 514
Page 10



Column scale seca 703
Page 56



Flat scale seca 874 dr
Page 71



Measuring station
seca 286 dp
Page 50

Gynecology & obstetrics



Column scale seca 703
Page 56



Flat scale seca 869
Page 67

Neonatology



Baby scale seca 727
Page 30



Infantometer seca 416
Page 38

Intensive care



Platform scale seca 656
Page 88



Bed and dialysis scale seca 984
Page 92

Cardiology



Column scale seca 703
Page 56



seca mBCA 514
Page 10

Pediatrics



Baby scale seca 374
Page 32



Infantometer seca 416
Page 38



Measuring station
seca 284 dp
Page 52



Acute care



seca mBCA 514
Page 10



Wheelchair scale seca 676
Page 86



Measuring station
seca 284 dp
Page 52



Stadiometer seca 274
Page 76

Long term care



seca mBCA 514
Page 10



Measuring station
seca 286 dp
Page 50



Wheelchair scale seca 676
Page 86

Endocrinology & diabetology



seca mBCA 514
Page 10



Measuring station
seca 284 dp
Page 52



Platform and bariatric
scale seca 634
Page 66



Telescopic measuring
rod seca 222
Page 79

Nephrology & dialysis



seca mBCA 514
Page 10



Multifunctional scale seca 684
Page 85



Platform scale seca 674
Page 89



Chair scale seca 954
Page 90

Field studies & mobile use



Baby scale seca 354
Page 36



Measuring board seca 417
Page 40



Mobile measuring and
weighing system
Page 69

Geriatrics



Chair scale seca 954
Page 90



Wheelchair scale seca 676
Page 86

Clinical nutrition



seca mBCA 514
Page 10









Measuring station
seca 286 dp
Page 50

For more information on seca products or services, contact us at:



1-800-542-7322

Baby scales







	 seca 727	 seca 374	 seca 334	 seca 354	 seca 725
	Digital baby scale with fine 1 g graduation with wireless transmission.	Digital baby scale with wireless transmission.	Digital baby scale with practical handle for mobile medical use.	Multi-purpose, digital baby scale also converts to flat scale for children.	Mechanical baby scale with sliding weights.
Page 28–37	Page 30	Page 32	Page 34	Page 36	Page 37
Technical data					
Capacity	44 lbs / 20 kg	44 lbs / 20 kg	44 lbs / 20 kg	44 lbs / 20 kg	16 kg
Graduation	0.1 oz 1 g < 6 kg > 2 g	0.2 oz < 22 lbs > 0.5 oz 5 g < 10 kg > 10 g	0.2 oz < 22 lbs > 0.5 oz 5 g < 10 kg > 10 g	0.5 oz < 22 lbs > 1 oz 10 g < 10 kg > 20 g	5 g
Dimensions (WxHxD)	21.7 x 5.9 x 12.6" 551 x 151 x 320 mm	24.4 x 7.5 x 14.1" 620 x 190 x 358 mm	25.1 x 4.1 x 11.8" 638 x 105 x 300 mm	21.7 x 6.1 x 13.1" 552 x 156 x 332 mm	21.7 x 7.1 x 11.4" 550 x 180 x 290 mm
Dimensions/tray (WxHxD)	21.3 x 4.3 x 9.8" 540 x 110 x 250 mm	24.2 x 5.1 x 10.8" 615 x 130 x 275 mm	23.4 x 2 x 10" 595 x 50 x 255 mm	20.7 x 3.1 x 9.8" 525 x 80 x 250 mm	21.7 x 4.3 x 10.6" 550 x 110 x 270 mm
Dimensions/platform (WxHxD)				11 x 2.6 x 9.3" 280 x 65 x 235 mm	
Weight	15.7 lbs / 7.1 kg	7.9 lbs / 3.6 kg	6.2 lbs / 2.8 kg	5 lbs / 2.3 kg	14.1 lbs / 6.4 kg
Power supply	Power adapter, rechargeable batteries	Batteries, power adapter optional	Batteries, power adapter optional	Batteries	
Functions					
TARE	•	•	•	•	
BMIF		•	•	•	
HOLD	•				
Auto-HOLD	•	•	•	•	
Automatic weighing range switch-over	•				
lbs/kg switch-over	•	•	•	•	
Damping	•	•			
Reset-to-zero function					•
Acoustic signals can be activated	•	•			
RESET	•	•			
Automatic switch-off	•	•	•	•	
SEND/Auto-SEND	•	•			
PRINT/Auto-PRINT	•	•			
Measuring rod included	•				
Optional					
Mobile carts	seca 403, seca 402	seca 403, seca 402	seca 403, seca 402	seca 403, seca 402	
Measuring rod/measuring board		seca 233	seca 232	seca 417	
Head/foot positioner		seca 418	seca 419		
Power adapter		seca 400	seca 400		
Interface cable					
Carrying case			seca 428	seca 409, seca 414, seca 431, seca 413	
Areas of application					
Mobile weighing	•		•	•	
System compatible with					
products of the seca 360° wireless system	•	•			
EMR	•	•			



Accessories for baby scales









							
	seca 403	seca 402	seca 233	seca 232	seca 418	seca 419	seca 400
	Cart for mobile support with customized indentations for seca baby scales seca 727, seca 728, seca 374, seca 334, and seca 354.	Cart for mobile support with customized indentations for seca baby scales seca 727, seca 728, seca 374, seca 334, and seca 354.	Measuring rod for baby scale seca 374.	Measuring rod for baby scale, accessory for seca 334.	Head and foot positioners for baby scale seca 374 when the measuring rod seca 233 is not installed.	Head positioners for baby scale seca 334.	Switch-mode power adapter for baby scales seca 374 and seca 334.
	Page 31	Page 31	Page 33	Page 35	Page 33	Page 34	Page 32
Technical data							
Maximum load	220 lbs / 100 kg	220 lbs / 100 kg					
Measuring range			14–32" / 35–80 cm	14–32" / 35–80 cm			
Graduation			1/8" / 1 mm	1/8" / 1 mm			
Dimensions (WxHxD)	28.2 x 31.5 x 17.1" 715 x 800 x 435 mm	28.2 x 31.5 x 17.1" 715 x 800 x 435 mm	25.2 x 7 x 11.7" 641 x 179 x 296 mm	25.2 x 5.7 x 10.9" 640 x 145 x 277 mm	8.1 x 5.8 x 2.7" 205 x 148 x 69 mm	8.1 x 5.7 x 1.8" 205 x 145 x 45 mm	1.7 x 1.4 x 2.9" 42 x 35 x 73 mm
Cable length							72.8" / 1.85 m
Weight	60.6 lbs / 27.5 kg	25.4 lbs / 11.5 kg	1.5 lbs / 700 g	1.1 lbs / 512 g	0.9 lbs / 400 g	0.3 lbs / 142 g	0.3 lbs / 155 g
Optional							
Paper roll holder		seca 408					

Accessories for baby scales

					
	seca 428	seca 409	seca 414	seca 431	seca 413
	Stable and roomy carrying case for the seca 334 baby scale.	Backpack to transport baby scale seca 354 together with the measuring board seca 417 or the measuring mat seca 210.	Case with handle and shoulder strap for electronic baby scale seca 354 in combination with seca 417 or seca 210.	Backpack to transport baby scales safely and comfortably.	Carrying case for baby scale seca 354.
	Page 35	Page 36	Page 36	Page 36	Page 37
Technical data					
Measuring range					
Graduation					
Dimensions (WxHxD)	24.8 x 13 x 4.3" 630 x 330 x 110 mm	14.6 x 24.8 x 5.5" 370 x 630 x 140 mm	24.6 x 13.8 x 8.3" 625 x 350 x 210 mm	15 x 22.8 x 6.7" 380 x 580 x 170 mm	22.4 x 5.9 x 13" 570 x 150 x 330 mm
Cable length					
Weight	2.6 lbs / 1.2 kg	3.5 lbs / 1.6 kg	6.2 lbs / 2.8 kg	1.8 lbs / 800 g	1.9 lbs / 900 g



Pediatric measuring systems









	 seca 416	 seca 417	 seca 210	 seca 207	 seca 212	 seca 218	 seca 211
	Infantometer with raised sides and footpiece mounted on two rails.	Light, space saving measuring board ideal for mobile use.	Measuring mat for babies and infants.	Measuring rod with extra-wide measuring slides. Wall mounting possible.	Head circumference measuring tape for babies and infants, made of non-stretch material. For measuring head circumference and symmetry.	Disposable measuring tape in practical wall dispenser.	Disposable measuring tape for head circumference in practical wall dispenser.
Page 38–47	Page 38	Page 40	Page 42	Page 44	Page 44	Page 45	Page 46
Technical data							
Measuring range	13–39" / 33–100 cm	4–39" / 10–100 cm	4–39" / 10–99 cm	0–39" / 0–99 cm	1–23" / 3–59 cm	0–36" / 0–100 cm	12–59 cm / 5–23"
Graduation	1/16" / 1 mm	1/16" / 1 mm	1/4" / 5 mm	1/8" / 1 mm	1/16" / 1 mm	1/8" / 1 mm	1 mm / 1/16"
Dimensions (WxHxD)	43.4 x 6.7 x 15.8" 1,103 x 169 x 402 mm	43.7 x 4.5 x 13.1" 1,110 x 115 x 333 mm	49.2 x 5.5 x 11.8" 1,250 x 140 x 300 mm	41.2 x 4.7 x 11.3" 1,047 x 120 x 286 mm	1 x 0.01 x 26.1" 25 x 0.2 x 663 mm 5.5 x 5.7 x 1.2" 140 x 145 x 30 mm	20 x 0.2 x 1,200 mm 0.8 x 0.01 x 47.2" 1.97 x 2.87 x 1.42" 50 x 73 x 36 mm	1 x 0.01 x 27.6" 25 x 0.2 x 701.5 mm 1.97 x 2.87 x 1.42" 50 x 73 x 36 mm
Dimensions box (WxHxD)							
Dimensions when folded (WxHxD)		22.7 x 4.5 x 13.1" 577 x 115 x 333 mm	4.7 x 5.5 x 11.8" 120 x 140 x 300 mm	41.2 x 4.7 x 1.2" 1,047 x 120 x 30 mm			
Weight	8.4 lbs / 3.8 kg	3.5 lbs / 1.6 kg	1.3 lbs / 575 g	1.8 lbs / 810 g	0.1 lbs / 60 g (box) 15 pieces	4 g / 0.14 oz 500 (inkl. dispenser) / 1,000 pieces	1.6 g / 0.06 oz 500 (inkl. dispenser) / 1,000 pieces
Quantity in dispenser							
Optional							
Carrying case/bag		seca 409, seca 414, seca 412	seca 409, seca 414				
Areas of application							
Can be mounted							
Mobile measuring		•	•	•	•		•

Accessories for pediatric measuring systems

	 seca 409	 seca 414	 seca 412	 seca 102	 seca 405 (b/g) seca 406 (b/g)	 seca 407 (b/g)
	Backpack to transport baby scale seca 354 together with the measuring board seca 417 or the measuring mat seca 210.	Case for the measuring instruments seca 417 together with baby scale seca 354.	Case for infantometer seca 417.	Convenient pads for recording a child's vital growth information.	Growth charts for boys (blue) and girls (pink) for tracking length/height, weight, head circumference and Body-Mass-Index percentiles by age.	Recommended for breast fed infants based on WHO (World Health Organization) standards. Covers up to 24 months.
Page 40	Page 40	Page 41	Page 47	Page 47	Page 47	
Technical data						
Dimensions (WxHxD)	14.6 x 24.8 x 5.5" 370 x 630 x 140 mm	24.6 x 13.8 x 8.3" 625 x 350 x 210 mm	27 x 16.8 x 2.2" 686 x 427 x 56 mm	4 1/4 x 5 1/2"	8 1/2 x 11"	8 1/2 x 11"
Weight	3.5 lbs / 1.6 kg	6.2 lbs / 2.8 kg	1.4 lbs / 650 g			
Quantity				Five 100-page pads per pack	100 sheets per pad	100 sheets per pad







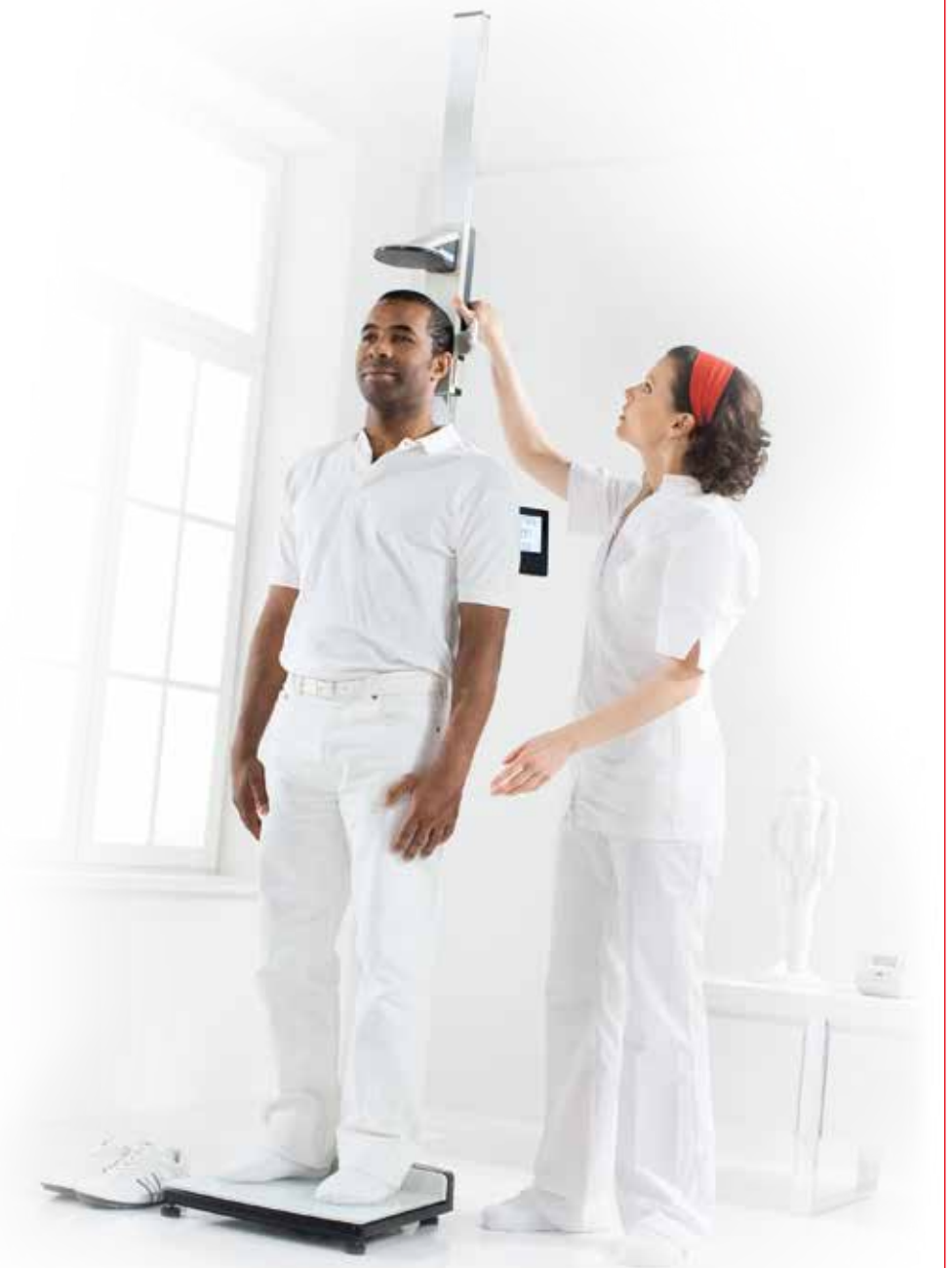





Measuring stations and column scales

	 CE 0123	 CE 0123	 CE 0123	 CE 0123	 CE 0123	 CE 0123	 CE 0123	 CE 0123
	seca 286 dp	seca 284 dp	seca 763	seca 703	seca 703 s	seca 769	seca 700	seca 755
	Wireless ultrasonic measuring station for height and weight with voice guidance.	Digital measuring station with wireless transmission of height and weight.	High-capacity digital measuring station consisting of scale, measuring rod and BMI calculator.	High capacity column scale with wireless transmission.	Wireless column scale with integrated measuring rod.	Digital column scale with BMI function, low-maintenance, easy to transport.	Mechanical column scale with eye-level beam.	Mechanical column scale with large dial and automatic display of the BMI range in kg or lbs version.
	Page 48–63	Page 50	Page 52	Page 54	Page 56	Page 58	Page 59	Page 60
Technical data								
Capacity	660 lbs / 300 kg	660 lbs / 300 kg	550 lbs / 250 kg	660 lbs / 300 kg	660 lbs / 300 kg	450 lbs / 200 kg	500 lbs, 220 kg or 400 lbs / 160 kg	350 lbs / 160 kg, 160 kg
Graduation	0.1 lbs / 50 g	0.1 lbs / 50 g	0.1 lbs / 50 g	0.1 lbs < 330 lbs > 0.2 lbs 50 g < 150 kg > 100 g 0.1 lbs < 23 sts > 0.2 lbs	0.1 lbs < 330 lbs > 0.2 lbs 50 g < 150 kg > 100 g 0.1 lbs < 23 sts > 0.2 lbs	0.2 lbs / 100 g	1/8 lbs, 50 g or 1/4 lbs / 100 g	1 lbs / 500 g, 500 g
Measuring range measuring rod	1 ft 11 5/8" – 6 ft 10 5/8" 60–210 cm	11" – 7 ft 2" 30–220 cm	43–79" / 110–200 cm		3–90" / 6–230 cm			
Graduation measuring rod	1/8" / 1 mm	1/8" / 1 mm	1/8" / 1 mm		1/8" / 1 mm			
Dimensions (WxHxD)	17.1 x 89.4 x 18.3" 434 x 2,270 x 466 mm	17.1 x 94.3 x 18.3" 434 x 2,394 x 466 mm	14.2 x 84.6 x 27.2" 360 x 2,150 x 690 mm	14.2 x 36.6 x 20.5" 360 x 930 x 520 mm	14.2 x 94.1 x 20.5" 360 x 2,390 x 520 mm	11.6 x 32.7 x 16.4" 294 x 831 x 417 mm	20.5 x 61.3 x 20.5" 520 x 1,556 x 520 mm	14.2 x 39.4 x 24.7" 360 x 1,000 x 628 mm
Dimensions/platform (WxHxD)	16.9 x 2.4 x 14.4" 430 x 60 x 365 mm	16.9 x 2.4 x 14.4" 430 x 60 x 365 mm	13.2 x 3.1 x 13.6" 335 x 80 x 345 mm	13.2 x 3.1 x 13.6" 335 x 80 x 345 mm	13.2 x 3.1 x 13.6" 335 x 80 x 345 mm	10.7 x 3 x 11" 272 x 75 x 280 mm	13.2 x 3.1 x 13.6" 335 x 80 x 345 mm	13.2 x 3.1 x 13.6" 335 x 80 x 345 mm
Weight	36.5 lbs / 16.5 kg	35.3 lbs / 16 kg	36.8 lbs / 16.7 kg	35 lbs / 15.9 kg	38.8 lbs / 17.6 kg	13.7 lbs / 6.2 kg	35.7 lbs / 16.2 kg	39.9 lbs / 18.1 kg
Power supply	Power adapter	Batteries, power adapter	Power adapter	Batteries, power adapter optional	Batteries, power adapter optional	Batteries, power adapter optional		
Functions/Accessories								
TARE	•	•	•	•	•	•	•	•
Pre-TARE	•	•	•	•	•	•	•	•
Mother/child function	•	•	•	•	•	•	•	•
HOLD	•	•	•	•	•	•	•	•
Auto-HOLD	•	•	•	•	•	•	•	•
BMI	•	•	•	•	•	•	•	•
Auto-BMI	•	•	•	•	•	•	•	•
BFR	•	•	•	•	•	•	•	•
Patient data input	•	•	•	•	•	•	•	•
CLEAR	•	•	•	•	•	•	•	•
Auto-CLEAR	•	•	•	•	•	•	•	•
lbs/kg switch-over	•	•	•	•	•	•	•	•
inch/cm switch-over	•	•	•	•	•	•	•	•
Damping	•	•	•	•	•	•	•	•
User-defined zero setting	•	•	•	•	•	•	•	•
Reset-to-zero function	•	•	•	•	•	•	•	•
Backlighting	•	•	•	•	•	•	•	•
Acoustic signals can be activated	•	•	•	•	•	•	•	•
RESET	•	•	•	•	•	•	•	•
Calibration/automatic calibration	•	•	•	•	•	•	•	•
Automatic switch-off	•	•	•	•	•	•	•	•
SEND/Auto-SEND	•	•	•	•	•	•	•	•
PRINT/Auto-PRINT	•	•	•	•	•	•	•	•
Integrated measuring rod	•	•	•	seca 220	seca 220	seca 220	seca 220	•
Transport castors	•	•	•	•	•	•	•	•
Optional								
Printer holder	seca 481 (for seca 465), seca 482 (for seca 466)	seca 481 (for seca 465), seca 482 (for seca 466)						
Measuring rod				seca 224		seca 224		seca 224
RS232 interface			seca 460					
Power adapter				seca 400	seca 400	seca 400		
System compatible with								
products of the seca 360° wireless system	•	•		•	•			
EMR	•	•		•	•			



Flat scales

									
	seca 634	seca 869	seca 874	seca 876	seca 874 dr	seca 813	seca 803	seca 762	seca 750
	Digital platform and bariatric scale with wireless transmission.	Robust flat scale with cable remote display, BMI, HOLD and TARE for mobile use.	Digital flat scale for mobile use with push buttons and double display.	Digital flat scale with integrated display.	Doctor's scale with customizable label.	High capacity digital flat scale for individual patient use.	Digital flat scale for individual patient use.	Mechanical flat scale with large dial and fine 1 lbs graduation.	Mechanical flat scale with robust, powder-coated steel casing. lbs/kg, kg and lbs version available.
Page 64–73	Page 66	Page 67	Page 68	Page 70	Page 71	Page 72	Page 72	Page 73	Page 73
Technical data									
Capacity	800 lbs / 360 kg	550 lbs / 250 kg	440 lbs / 200 kg	550 lbs / 250 kg	440 lbs / 200 kg	440 lbs / 200 kg	330 lbs / 150 kg	320 lbs, 150 kg, 320 lbs / 150 kg	320 lbs, 150 kg, 320 lbs / 150 kg
Graduation	0.1 lbs / 50 g	0.2 lbs < 330 lbs > 0.5 lbs 100 g < 150 kg > 200 g	0.1 lbs < 330 lbs > 0.2 lbs 50 g < 150 kg > 100 g	0.2 lbs < 330 lbs > 0.5 lbs 100 g < 150 kg > 200 g	0.1 lbs < 330 lbs > 0.2 lbs 50 g < 150 kg > 100 g	0.2 lbs / 100 g	0.2 lbs / 100 g	1 lbs, 500 g, 1 lbs / 500 g	1 lbs, 1 kg, 1 lbs / 1 kg
Dimensions (WxHxD)	25.2 x 2.1 x 23.6" 640 x 53 x 600 mm	12.6 x 2.4 x 14" 321 x 60 x 356 mm	12.6 x 2.4 x 14.2" 321 x 60 x 361 mm	12.6 x 2.4 x 14" 321 x 60 x 356 mm	12.6 x 2.4 x 14.2" 321 x 61 x 361 mm	17 x 1.9 x 14.7" 433 x 47 x 373 mm	12.4 x 1.5 x 12.8" 316 x 37 x 326 mm	12 x 4.7 x 18.5" 305 x 120 x 470 mm	12.5 x 4.6 x 18.8" 317 x 117 x 477 mm
Dimensions/platform (WxHxD)	22 x 2.2 x 22" 560 x 55 x 560 mm	11 x 2.4 x 10.9" 280 x 60 x 278 mm	11.3 x 2.4 x 11" 288 x 60 x 280 mm	11.3 x 2.4 x 10.9" 288 x 60 x 278 mm	11.3 x 2.4 x 11" 288 x 60 x 280 mm	15.7 x 1.8 x 11.8" 400 x 45 x 300 mm	11.6 x 1.4 x 12" 295 x 35 x 305 mm	10.2 x 2.8 x 10.4" 260 x 70 x 265 mm	11.4 x 2.8 x 11.4" 290 x 70 x 290 mm
Cable length	98.4" / 2.5 m	78.7" / 2 m							
Weight	31.7 lbs / 14.4 kg	9.9 lbs / 4.5 kg	9 lbs / 4.1 kg	9.3 lbs / 4.2 kg	9 lbs / 4.1 kg	6.4 lbs / 2.9 kg	3.3 lbs / 1.5 kg	7.7 lbs / 3.5 kg	7.7 lbs / 3.5 kg
Power supply	Batteries, power adapter optional	Batteries, power adapter optional	Batteries	Batteries	Batteries	Batteries	Batteries		
Functions									
TARE	•	•							
Pre-TARE	•								
Mother/child function			•	•	•				
HOLD	•	•							
Auto-HOLD	•		•		•	•	•		
Step-off						•			
BMI	•	•							
lbs/kg switch-over	•	•	•	•	•	•	•		
Auto-CLEAR	•								
Damping	•								
Reset-to-zero function								•	•
Tip-on automatic switch-on				•		•	•		
RESET	•								
Automatic switch-off	•	•	•	•	•	•	•		
SEND/Auto-SEND	•								
PRINT/Auto-PRINT	•								
Transport castors	•								
Optional									
Measuring rod		seca 217	seca 217	seca 217					
Stand for cable remote display	seca 472								
Adapter element		seca 437	seca 437	seca 437					
Power adapter	seca 400	seca 400			seca 400				
Carrying case		seca 409, seca 414, seca 421	seca 409, seca 414, seca 415	seca 409, seca 414, seca 415			seca 415		
Individualizable label					seca 478				
Areas of application									
Mobile weighing		•	•	•			•		
System compatible with									
products of the seca 360° wireless system	•								
EMR	•								













Accessories for measuring stations, column and flat scales

											 new
	seca 224	seca 220	seca 472	seca 437	seca 460	seca 400	seca 409	seca 414	seca 421	seca 415	seca 478
	Telescopic measuring rod for seca column scales.	Telescopic measuring rod for seca column scales.	Stand for display elements of seca scales with cable remote displays.	Adapter element for the flat scales seca 869, seca 874 and seca 876 in combination with stadiometer seca 217.	RS232 interface for transmitting data to the serial interface of a PC or printer for seca 763.	Switch-mode power adapter for column and flat scales seca 703, seca 769, seca 634 and seca 869.	Backpack to transport the flat scales seca 869, seca 874, and seca 876 together with the stadiometer seca 217 and the adapter element seca 437.	Case for the flat scale seca 869, seca 874 or seca 876 together with stadiometer seca 217 and adapter element seca 437.	Stable and roomy carrying case for most flat scales.	Carrying case for the flat scales seca 874, seca 876 and seca 803.	Customizable label for doctor scale 874 dr.
	Page 59	Page 61	Page 67	Page 69	Page 55	Page 57	Page 68	Page 67	Page 67	Page 71	Page 71
Technical data											
Measuring range	24–78" / 60–200 cm	24–78" / 60–200 cm									
Graduation	1/8" / 1 mm	1/8" / 1 mm									
Dimensions (WxHxD)	2.2 x 58.3 x 11.3" 55 x 1,480 x 286 mm	2.2 x 58.3 x 11.3" 55 x 1,480 x 286 mm	18.1 x 40.7 x 18.1" 460 x 1,035 x 460 mm	13.1 x 3.4 x 12.2" 333 x 86 x 310 mm	3.9 x 1 x 2.4" 100 x 25 x 60 mm 11.8 + 47.2" / 0.3 m + 1.2 m	1.7 x 1.4 x 2.9" 42 x 35 x 73 mm 72.8" / 1.85 m	14.6 x 24.8 x 5.5" 370 x 630 x 140 mm	24.6 x 13.8 x 8.3" 625 x 350 x 210 mm	16.9 x 13.8 x 5.1" 430 x 350 x 130 mm	13 x 15 x 2.8" 330 x 380 x 70 mm	257 x 32 x 2 mm 10 x 1.3 x 0.1"
Cable length											
Weight	3.1 lbs / 1.4 kg	1.5 lbs / 700 g	17.2 lbs / 7.8 kg	1.3 lbs / 600 g	0.3 lbs / 122 g	0.3 lbs / 155 g	3.5 lbs / 1.6 kg	6.2 lbs / 2.8 kg	1.8 lbs / 810 g	800 g / 1.8 lbs	2 g / 0.07 lbs









Height measuring systems

	 seca 274 €€ 0123	 seca 264 €€ 0123	 seca 217 €€ 0123	 seca 213 €€ 0123	 seca 222 €€ 0123	 seca 216 €€ 0123	 seca 206 €€ 0123	 seca 203 €€ 0123	 seca 201 €€ 0123
	Digital mobile stadiometer with wireless transmission.	Digital stationary stadiometer with wireless transmission.	Stand-alone stadiometer for height measurement, with spacer, consisting of parts that fit together perfectly for ease of transport.	Stand-alone stadiometer for height measurement, easily assembled for convenient transport.	Telescopic measuring rod for the wall with extrawide measuring slides and heel stop.	Mechanical stadiometer. Head piece with locking screw for accuracy.	Roll-up measuring tape with wall attachment.	Ergonomic, smoothly extractable circumference measuring tape with WHR calculator to determine body fat distribution.	Ergonomic, smoothly extractable measuring tape for determining body circumference.
Page 74–81	Page 76	Page 77	Page 78	Page 79	Page 79	Page 80	Page 80	Page 81	Page 81
Technical data									
Measuring range	11"–7 ft 2" 30–220 cm	11"–7 ft 2" 30–220 cm	8"–81" / 20–205 cm	8"–81" / 20–205 cm	2–90" / 6–230 cm	max. 55.3" / 138 cm selectable from 1.4–90" / 3.5–230 cm	0–87" / 0–220 cm	0–80" / 0–205 cm	0–80" / 0–205 cm
Graduation	1/8" / 1 mm	1/8" / 1 mm	1/8" / 1 mm	1/8" / 1 mm	1/8" / 1 mm	1/16" / 1 mm	1/8", 1 mm	1/8", 1 mm	1/8", 1 mm
Dimensions (WxHxD)	17.1 x 94.3 x 18.3" 434 x 2,394 x 466 mm	16.9 x 91.3 x 18.7" 428 x 2,318 x 474 mm	12.9 x 84.4 x 22.6" 328 x 2,145 x 574 mm	13.3 x 83.9 x 23.2" 337 x 2,130 x 590 mm	12.1 x 91.3 x 11.3" 308 x 2,320 x 286 mm	4.7 x 59.1 x 8.5" 120 x 1,500 x 217 mm	4.9 x 4.9 x 6.8" 125 x 125 x 173 mm	2.8 x 1.1 x 2.6" 70 x 28 x 66 mm	2.8 x 0.9 x 2.6" 70 x 22 x 65 mm
Dimensions/platform (WxHxD)	16.9 x 2.4 x 14.4" 430 x 60 x 365 mm	16.9 x 0.1 x 14.6" 430 x 3 x 370 mm							
Dimensions when folded (WxHxD)				13.3 x 7 x 24.6" 337 x 177 x 624 mm	12.1 x 52 x 11.3" 308 x 1,320 x 286 mm				
Weight	33.1 lbs / 15 kg	11 lbs / 5 kg	7.9 lbs / 3.6 kg	5.3 lbs / 2.4 kg	2.4 lbs / 1.1 kg	3.7 lbs / 1.7 kg	0.4 lbs / 202 g	0.2 lbs / 70 g	0.1 lbs / 50 g
Power supply	Batteries	Batteries							
Functions									
HOLD	•	•							
WHR calculator								•	
inch/cm switch-over	•	•							
User-defined zero setting	•	•							
Backlighting	•	•							
Acoustic signals can be activated	•	•							
RESET	•	•							
Calibration/automatic calibration	•	•							
Automatic switch-off	•	•							
SEND/Auto-SEND	•	•							
PRINT/Auto-PRINT	•	•							
Transport castors	•								
Optional									
Adapter element			seca 437						
Carrying case			seca 409, seca 414, seca 412	seca 412					
Areas of application									
Can be mounted		•			•	•	•	•	•
Mobile measuring			•	•				•	•
System compatible with									
products of the seca 360° wireless system	•	•							
EMR	•	•							

Accessories for height measuring systems

	 seca 437	 seca 409	 seca 414	 seca 412
	Adapter element for stadiometer seca 217 in combination with flat scales seca 869, seca 874 and seca 876..	Backpack to transport the flat scales seca 876, seca 874 and seca 869 together with the stadiometer seca 217 and the adapter element seca 437.	Case for stadiometer seca 217 together with flat scale seca 876, seca 874 or seca 869 and adapter element seca 437.	Case for mobile stadiometer seca 217 or seca 213.
Page 78	Page 78	Page 78	Page 78	Page 78
Technical data				
Dimensions (WxHxD)	13.1 x 3.4 x 12.2" 333 x 86 x 310 mm	370 x 630 x 140 mm	24.6 x 13.8 x 8.3" 625 x 350 x 210 mm	27 x 16.8 x 2.2" 686 x 427 x 56 mm
Weight	1.3 lbs / 600 g	3.5 lbs / 1.6 kg	6.2 lbs / 2.8 kg	1.4 lbs / 650 g

Multifunctional and wheelchair scales

	 seca 644	 seca 684	 seca 676	 seca 664	 seca 656	 seca 674
						
	Digital multifunctional handrail scale with wireless transmission.	Digital multifunctional scale with stable handrail and high load bearing capacity.	Digital wheelchair scale with handrail and wireless transmission.	Digital wheelchair scale with wireless transmission.	High capacity digital stretcher scale with wireless transmission.	High capacity digital platform scale with transport castors.
Page 82–89	Page 84	Page 85	Page 86	Page 87	Page 88	Page 89
Technical data						
Capacity	800 lbs / 360 kg	800 lbs / 360 kg	800 lbs / 360 kg	800 lbs / 360 kg	800 lbs / 360 kg	800 lbs / 360 kg
Graduation	0.1 lbs / 50 g	0.1 lbs / 50 g	0.1 lbs / 50 g	0.1 lbs / 50 g	0.1 lbs / 50 g	0.1 lbs / 50 g
Dimensions (WxHxD)	25.2 x 45.3 x 26" 640 x 1,150 x 660 mm	35.8 x 43.3 x 41.9" 910 x 1,100 x 1,064 mm	36.2 x 44.1 x 45.3" 920 x 1,120 x 1,150 mm	43.4 x 35.9 x 45.3" 1,102 x 912 x 1,150 mm	35.2 x 3.4 x 65.2" 893 x 87 x 1,655 mm	35.6 x 2.8 x 41.9" 904 x 70 x 1,064 mm
Dimensions/platform (WxHxD)	23.6 x 2.2 x 23.6" 600 x 55 x 600 mm	31.5 x 2 x 33.1" 800 x 50 x 840 mm	31.5 x 2.2 x 38" 800 x 55 x 965 mm	31.5 x 2.2 x 38" 800 x 55 x 965 mm	31.5 x 2.2 x 57.7" 800 x 55 x 1,465 mm	31.5 x 2.2 x 38" 800 x 55 x 965 mm
Weight	55.9 lbs / 25.4 kg	131.2 lbs / 59.5 kg	83.8 lbs / 38 kg	73.6 lbs / 33.4 kg	101.9 lbs / 46.2 kg	59.5 lbs / 27 kg
Power supply	Power adapter, rechargeable batteries	Power adapter	Power adapter	Power adapter, rechargeable batteries	Power adapter	Power adapter
Functions/Accessories						
TARE/Pre-TARE	•	•	•	•	•	•
HOLD	•	•	•	•	•	•
Auto-HOLD	•	•	•	•	•	•
BMI	•	•	•	•	•	•
Auto-CLEAR	•	•	•	•	•	•
lbs/kg switch-over	•	•	•	•	•	•
Damping	•	•	•	•	•	•
RESET	•	•	•	•	•	•
Automatic switch-off	•	•	•	•	•	•
SEND/Auto-SEND	•	•	•	•	•	•
PRINT/Auto-PRINT	•	•	•	•	•	•
Transport castors	•					•
Ramp		1 x seca 470	2 x integrated	2 x integrated	2 x integrated	1 x seca 470
Version						
RS232 interface		seca 684 r (incl. dialysis interface cable)	seca 676 r (incl. dialysis interface cable)			
Optional						
Mechanical accessories	Measuring rod seca 223				Stand for cable remote display seca 472	Stand for cable remote display seca 472, additional ramp seca 470
PC interface cable		seca 451 (only for seca 684 r)	seca 451 (only for seca 676 r)			
System compatible with						
products of the seca 360° wireless system	•	•	•	•	•	•
EMR	•	•	•	•	•	•

Accessories for multifunctional and wheelchair scales

	 seca 223	 seca 472	 seca 470	 seca 451
				
	Telescopic measuring rod for the seca 644 handrail scale.	Stand for display elements of seca scales with cable remote displays.	Drive-up ramp as accessory for seca 674.	PC interface cable (female) for the multifunctional and wheelchair scale seca 684 r and seca 676 r.
Page 84	Page 89	Page 89	Page 85	
Technical data				
Measuring range	2–90" / 6–230 cm			
Graduation	1/8" / 1 mm			
Dimensions (WxHxD)	4.7 x 91.3 x 11.3" 120 x 2,320 x 286 mm	18.1 x 40.7 x 18.1" 460 x 1,035 x 460 mm	31.9 x 1.4 x 9.8" 810 x 35 x 250 mm	31.9 x 1.4 x 9.8" 810 x 35 x 250 mm
Cable length				43.3" / 1.1 m
Weight	2.1 lbs / 952 g	17.2 lbs / 7.8 kg	4.3 lbs / 2 kg	0.09 lbs / 40 g



Chair scales



seca 954
Digital chair scale with wireless transmission.

seca 952
Digital chair scale with fold up armrests and footrests.

Page 90-91 Page 90 Page 91

Technical data	
Capacity	660 lbs / 300 kg
Graduation	0.1 lbs < 330 lbs > 0.2 lbs / 50 g < 150 kg > 100 g
Dimensions (WxHxD)	22.2 x 35.3 x 38.5" / 563 x 897 x 978 mm
Weight	54 lbs / 24.5 kg
Power supply	Power adapter, rechargeable batteries
Directive	MP/EMC
Functions	
TARE	•
Pre-TARE	•
HOLD	•
Auto-HOLD	•
BMI	•
lbs/kg switch-over	•
Damping	•
RESET	•
Automatic switch-off	•
SEND/Auto-SEND	•
PRINT/Auto-PRINT	•
RS232 compatible	•
System compatible with	
products of the seca 360° wireless system	•
EMR	•

Bed and dialysis scale



seca 984
Digital bed and dialysis scale with integrated mechanical lifters and equipment trolley.

Page 92

Technical data	
Capacity	1,100 lbs / 500 kg
Graduation	0.2 lbs < 440 lbs > 0.5 lbs / 100 g < 200 kg > 200 g
Dimensions/cart (WxHxD)	20.5 x 36.5 x 22.1" / 520 x 927 x 562 mm
Dimensions/load cells (WxHxD)	12.9 x 5.9 x 8.3" / 328 x 150 x 212 mm
Weight	56.4 lbs / 25.6 kg (load cells + cart)
Power supply	Power adapter, rechargeable batteries
Directive	MP/EMC
Functions	
TARE/Pre-TARE	•
HOLD	•
BMI	•
Lower limit value	•
lbs/kg switch-over	•
Damping	•
Optional	
RS232 interface	seca 460

Accessories for bed and dialysis scale



seca 460
RS232 interface for transmitting data to PC and/or printer for seca 984.

Page 93

Technical data	
Dimensions (WxHxD)	3.9 x 1 x 2.4" / 100 x 25 x 60 mm
Cable length	11.8 + 47.2" / 0.3 m + 1.2 m
Weight	0.3 lbs / 122 g

Organ and diaper scale



seca 856
Organ and diaper scale with protected electronics for precise determination of net weight.

Page 94

Technical data	
Capacity	11 lbs / 5 kg
Graduation	0.05 oz < 6.6 lbs > 0.1 oz / 1 g < 3 kg > 2 g
Dimensions (WxHxD)	10.4 x 2.1 x 10.4" / 265 x 53 x 265 mm
Dimensions/scale platform (WxHxD)	9.3 x 0.2 x 6.7" / 235 x 5 x 170 mm
Weight	4.2 lbs / 1.9 kg
Power supply	Batteries
Directive	EMC
Functions	
TARA	•
Pre-TARA	•
HOLD	•
lbs/kg switch-over	•
Automatic switch-off	•

Digital portion and diet scale





seca 852
Digital portion and diet scale with perfect fitting bowl for safe storage, finest graduation.

Page 95

Technical data	
Capacity	6.6 lbs / 3 kg
Graduation	0.05 oz / 1 g
Dimensions (WxHxD)	8.3 x 5.5 x 8.3" / 210 x 140 x 210 mm
Dimensions/scale platform (WxHxD)	5.5 x 2.1 x 5.5" / 140 x 53 x 140 mm
Weight	1.6 lbs / 710 g
Power supply	Batteries
Directive	EMC
Functions	
TARE	•
lbs/kg switch-over	•
Automatic switch-off	•





Digital printers with wireless reception

		
	seca 466	seca 465
	Digital printer with wireless reception and analysis of measurements on thermal paper or labels.	Digital printer with wireless reception and analysis of measurements on thermal paper.
Page 96–97	Page 96	Page 97
Technical data		
Dimensions (WxHxD)	4.2 x 4.1 x 7.1" 106 x 105 x 180 mm	4.2 x 4.6 x 6.7" 106 x 116.5 x 170 mm
Weight	2.2 lbs / 1 kg	1.8 lbs / 800 g
Power supply	Power adapter seca 360° wireless technology	Power adapter seca 360° wireless technology
Data transmission	80 mm/sec	80 mm/sec
Print speed	48 mm	48 mm
Print width		
Functions/Accessories		
Print-out	Height, weight, BMI, resting or total energy expenditure or percentiles for children	Height, weight, BMI, resting or total energy expenditure or percentiles for children
Integrated automatic cutter	•	
Optional		
Thermal paper seca 485	5 or 50 rolls	5 or 50 rolls
Labels seca 486	1 or 24 rolls	
System compatible with		
products of the seca 360° wireless system	all scales and measuring instruments in the seca 360° wireless system	all scales and measuring instruments in the seca 360° wireless system
EMR	•	•
Included with printer		
SD smart card	•	•
Power adapter	•	•
SD card reader	•	•
1 roll of thermal paper	•	•
1 roll of labels	•	•



Accessories for digital printers

		
	seca 485	seca 486
	Thermal paper rolls for seca 360° wireless printers seca 466 and seca 465.	Roll of labels for seca 360° wireless printer seca 466.
Page 96	Page 96	Page 96
Technical data		
Dimensions (WxHxD)	2.2 x 2.3 x 2.3" 57 x 59 x 59 mm	2.3 x 2.5 x 2.5" 58 x 64 x 64 mm
Weight	0.3 lbs / 140 g	0.3 lbs / 140 g
Packaging unit	5 or 50 rolls	1 or 24 rolls

Software

		
	seca analytics 115	seca emr flash 101
	Medical PC software for diagnostic assistance.	software to connect seca 360° wireless products to Electronic Medical Record (EMR) Systems.
Page 98–101	Page 98	Page 100
Technical data		
Dimensions (WxHxD)	5.4 x 7.6 x 0.3" 137 x 192 x 7 mm	
Weight	0.2 lbs / 78 g	
System requirements		
Supported operating systems	Windows® 10, Windows® 8.1, Windows® 8, Windows® Server 2012 R2, Windows® Server 2012, Windows® 7 (SP1), Windows® Vista (SP1, SP2), Windows® Server 2008 R2 and Windows® Server 2008	Windows® 10, Windows® 8.1, Windows® 8, Windows® 7 (SP1) and Windows® Vista (SP1, SP2)
Processor	1.2 GHz or higher	
Memory	minimum 512 MB RAM	
Additional HW	DVD drive	
Ports	for usage in combination with seca medical devices USB port (2.0) or serial interface (RS232)	for usage in combination with seca medical devices USB port (2.0) or serial interface (RS232)
Display	1,024 x 768, High Colour (16-bit), 32-bit (recommended)	
System compatible with		
products of the seca 360° wireless system	all scales and measuring instruments in the seca 360° wireless system	all scales and measuring instruments in the seca 360° wireless system
EMR	•	•

Accessories for software

		
	seca 456	seca 456 wa
	seca 360° wireless USB adapter for wireless data reception.	seca 360° wireless USB adapter for data reception and transmission to a Welch Allyn CVSM, Welch Allyn Connex® Spot Monitor or Integrated Wall System.
Page 101	Page 101	Page 101
Technical data		
Dimensions (WxHxD)	3.3 x 0.9 x 0.4" 85 x 23 x 10 mm	3.3 x 0.9 x 0.4" 85 x 23 x 10 mm
Weight	0.026 lbs / 12 g	0.026 lbs / 12 g
System requirements		
Supported operating systems	Windows® 10, Windows® 8.1, Windows® 8, Windows® Server 2012 R2, Windows® Server 2012, Windows® 7 (SP1), Windows® Vista (SP1, SP2), Windows® Server 2008 R2 and Windows® Server 2008	Windows® 8.1, Windows® 8, Windows® Server 2012 R2, Windows® Server 2012, Windows® 7 (SP1), Windows® Vista (SP1, SP2), Windows® Server 2008 R2 and Windows® Server 2008
Ports	for usage in combination with seca medical devices USB port (2.0)	for usage in combination with seca medical devices USB port (2.0)
System compatible with		
products of the seca 360° wireless system	all scales and measuring instruments in the seca 360° wireless system	all scales and measuring instruments in the seca 360° wireless system
EMR	•	•

