

Pressure Monitoring

Product Catalog



Pressure
Infusor
Bags



Pressure
Transducers



Closed Blood
Sampling



Accessories and
Components



Pressure
Monitoring
Cables



The Right Choice.

 PRESSURE INFUSOR BAGS.....	4
Clear-Cuff®	4
C-Fusor® Pressure Infusors	4
 PRESSURE TRANSDUCER.....	7
DISPOSABLE TRANSDUCER SYSTEMS.....	8
TranStar® Pressure Transducer Single Kits.....	8
TranStar® Pressure Transducer Double Kits	9
TranStar® Pressure Transducer Triple Kits.....	9
TranStar® Pressure Monitoring Kits.....	10
REUSABLE TRANSDUCER SYSTEMS	11
LogiCal® Pressure Transducer Single Kits	11
LogiCal® Pressure Transducer Double Kits	12
LogiCal® Pressure Transducer Triple Kits	12
LogiCal® Pressure Transducer Cartridges.....	13
LogiCal® Pressure Transducer System Component	13
 CLOSED BLOOD SAMPLING SYSTEMS.....	15
Add-On Closed Blood Sampling	16
TranStar® Kids Kit™ Neonatal Closed Blood Sampling System	18
TranStar® HemoDraw® Plus Single Line Closed Blood Sampling System.....	19
TranStar® HemoDraw® Plus Double Line Closed Blood Sampling System.....	20
TranStar® HemoDraw® Plus Triple Line Closed Blood Sampling System.....	21
LogiCal® Kids Kit™ Neonatal Closed Blood Sampling System	22
LogiCal® HemoDraw® Plus Single Line Closed Blood Sampling System.....	23
LogiCal® HemoDraw® Plus Double Line Closed Blood Sampling System	24
LogiCal® HemoDraw® Plus Triple Line Closed Blood Sampling System.....	24
 ACCESSORIES AND COMPONENTS	27
TranStar® Mounting Accessories.....	28
LogiCal® Mounting Accessories	28
Blood Sampling Access Devices	29
HemoDraw® Plus Mounting Accessories	29
Flush Devices.....	30
Pressure Monitoring Tubing with Male/Female Luer Lock.....	30
Pressure Monitoring Tubing with Male/Male Luer Lock	31
Pressure Monitoring Tubing with Male/Female Luer Lock (Red).....	31
Pressure Monitoring Tubing with Male/Female Luer Lock (Low Volume)	31
Non-Vented Administration Sets.....	32
Pressure Monitoring Components	33
Manometers.....	34
 PRESSURE MONITORING CABLES.....	35
Pressure Monitoring Cables	35
 INDEX	37



PRESSURE INFUSORS

Clear-Cuff® 4

C-Fusor® Pressure Infusors 4

Clear-Cuff®

ORDERING INFORMATION

Clear-Cuff®		
Code	Description	Units per Case
MX4705	Clear-Cuff® 500 mL Reusable Pressure	10
MX4710	Clear-Cuff® 1000 mL Reusable Pressure	10

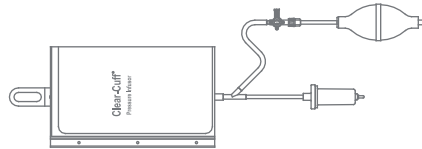

C-Fusor® Pressure Infusors

ORDERING INFORMATION

C-Fusor® Disposable Dome		
Code	Description	Units per Case
MX4805	C-Fusor® 500 mL Pressure Infusor	1
MX4810	C-Fusor® 1000 mL Pressure Infusor	1
MX4830	C-Fusor® Extension 3000 mL	1
MX1821B	C-Fusor® Replacement Squeeze Bulb Assembly	1
MX1821G	C-Fusor® Replacement Pressure Gauge	1

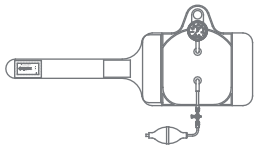

MX4810



MX4830

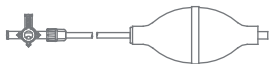

MX1821B

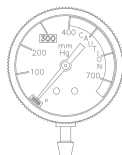

MX1821G

PRESSURE TRANSDUCERS

Disposable Transducer Systems



TranStar® Pressure Transducer Single Kits.....	8
TranStar® Pressure Transducer Double Kits	9
TranStar® Pressure Transducer Triple Kits.....	9
TranStar® Pressure Monitoring Kits.....	10

Reusable Transducer Systems



LogiCal® Pressure Transducer Single Kits	11
LogiCal® Pressure Transducer Double Kits	12
LogiCal® Pressure Transducer Triple Kits	12
LogiCal® Pressure Transducer Cartridges.....	13
LogiCal® Pressure Transducer System Component	13

TranStar® Pressure Transducer Single Kits

ORDERING INFORMATION

TranStar® Pressure Transducer Single Kits

Code	Description	Units per Case
MX9501T	TranStar® 12" [29 cm] Patient Mount Monitoring Kit	10

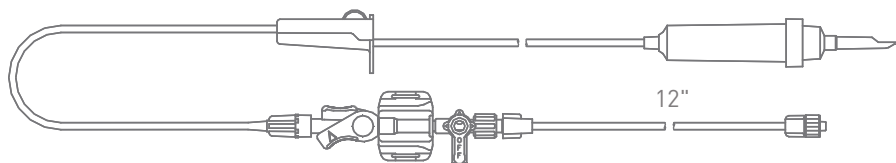

MX9504T	TranStar® 60" [152 cm] Single Monitoring Kit	10
---------	--	----

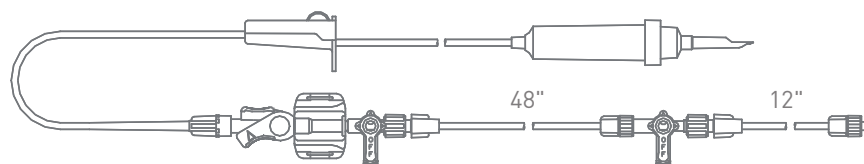

MX9505T	TranStar® 84" [213 cm] Single Monitoring Kit	10
---------	--	----

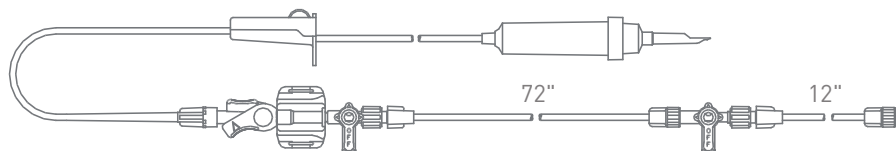

MX9510T	TranStar® 72" [183 cm] Single Line (without Administration Set), may be used with MX9513T	10
---------	---	----

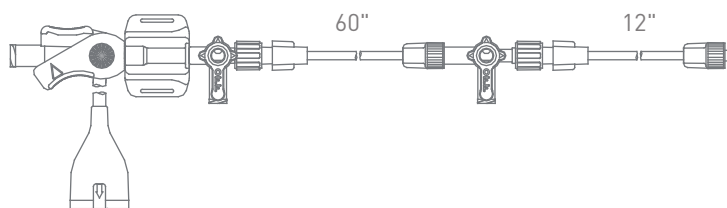

MX9530T	Neonatal TranStar® Monitoring Kit, 12", 30 cc/hr, Flush Device with Orange Insert (Neonatal)	10
---------	--	----



TranStar® Pressure Transducer Double Kits

ORDERING INFORMATION

TranStar® Pressure Transducer Double Kits		
Code	Description	Units per Case
MX9502T	TranStar® 72" (183 cm) Double Monitoring Kit	10

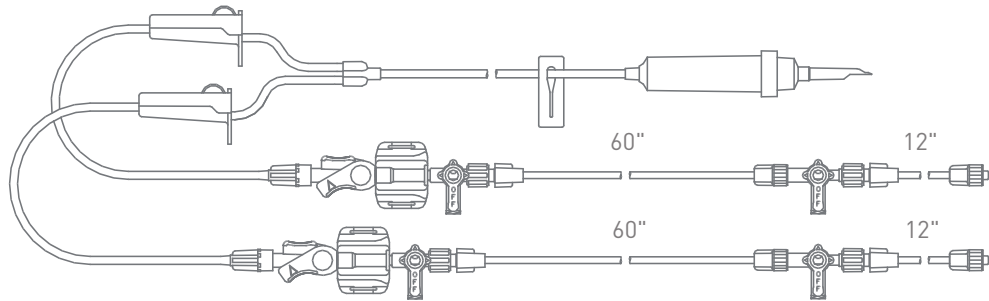

TranStar® Pressure Transducer Triple Kits

ORDERING INFORMATION

TranStar® Pressure Transducer Triple Kits		
Code	Description	Units per Case
MX9506T	TranStar® 72" (183 cm) Triple Monitoring Kit	10

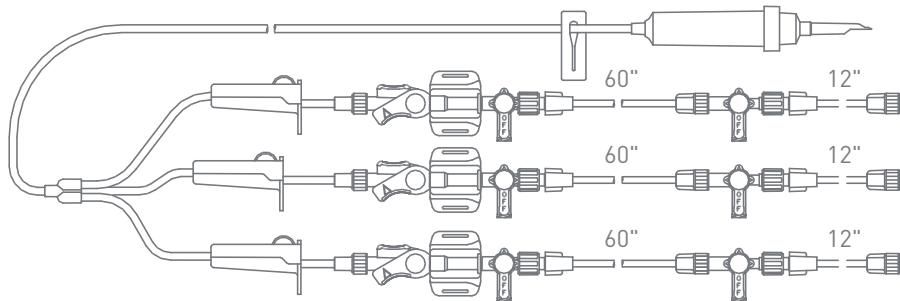



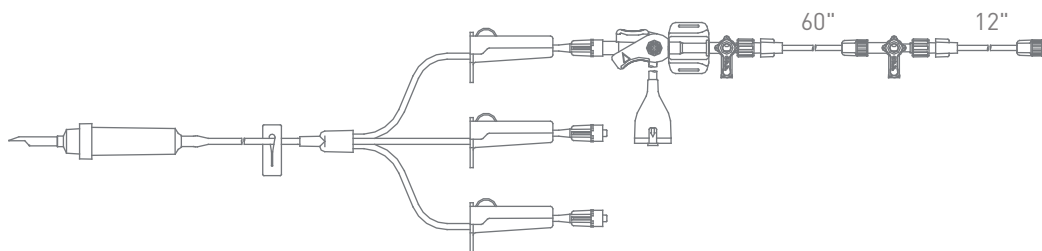

MX9513T	TranStar® 72" (183 cm) Trifurcated Add-On Kit, may be used with MX9510T	10
---------	---	----

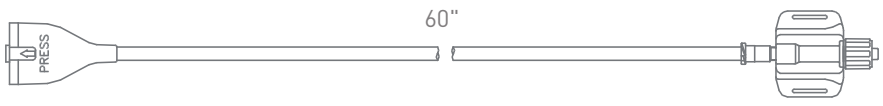

TranStar® Pressure Transducers

ORDERING INFORMATION

TranStar® Disposable Pressure Transducer		
Code	Description	Units per Case
MX950	12" Cable	10
		
MX950L	60" Cable	5
		
MX950XSC	One Stopcock	10
		
MX950X2SC	Two Stopcocks	10
		
MX950SCFT	With one Stopcock and 3 cc/hr Flush	10
		
MX950SCNT	With one Stopcock and 30 cc/hr Flush with Orange Insert (Neonatal)	10
		

LogiCal® Pressure Transducer Single Kits

ORDERING INFORMATION

LogiCal® Pressure Transducer Single Kits

Code	Description	Units per Case
MX9601A	LogiCal® 12" (29 cm) Patient Mount Monitoring Kit	10

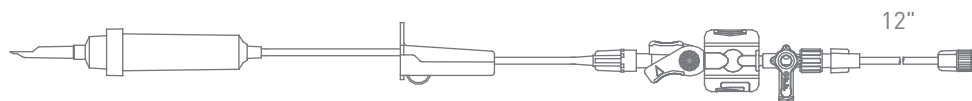

MX9604A	LogiCal® 60" (152 cm) Single Monitoring Kit	10
---------	---	----

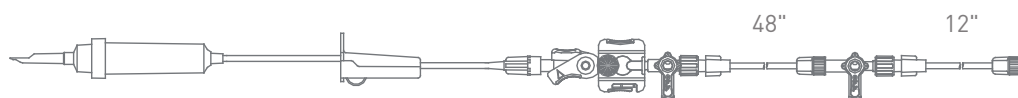

MX9605A	LogiCal® 84" (213 cm) Single Monitoring Kit	10
---------	---	----

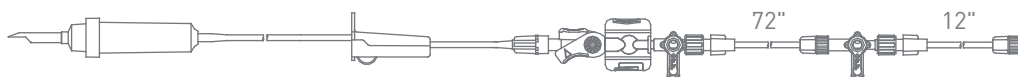

MX9630A	Neonatal LogiCal® 12" Monitoring Kit, 30 cc/hr, Flush Device with Orange Insert (Neonatal)	10
---------	--	----



LogiCal® Pressure Transducer Double Kits

ORDERING INFORMATION

LogiCal® Pressure Transducer Double Kits		
Code	Description	Units per Case
MX9602A	LogiCal® 84" (213 cm) Double Monitoring Kit	10

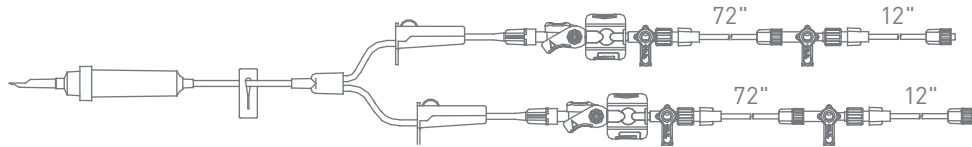

LogiCal® Pressure Transducer Triple Kits

ORDERING INFORMATION

LogiCal® Pressure Transducer Triple Kit		
Code	Description	Units per Case
MX9606A	LogiCal® 72" (183 cm) Triple Monitoring Kit	10

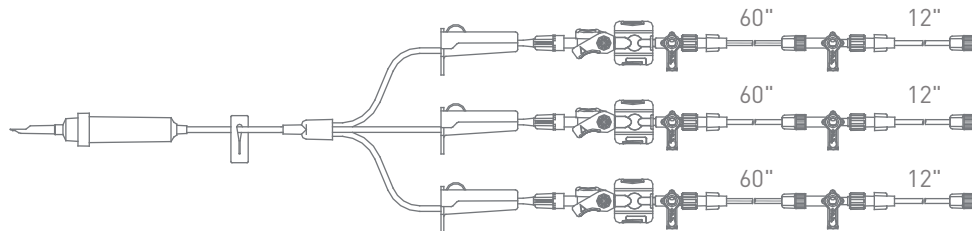

LogiCal® Pressure Transducer Cartridges

ORDERING INFORMATION

LogiCal® Pressure Transducer Cartridges

Code	Description	Units per Case
MX960XX	Male/Male	50

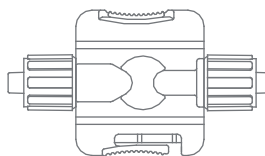

MX960X2SC	Two Stopcocks	25
-----------	---------------	----

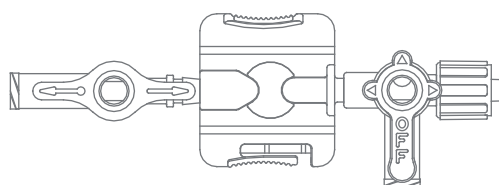

MX960XY	Male/Female	50
---------	-------------	----

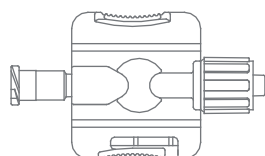

MX960SCFA	One Stopcock and 3 cc Flush	10
-----------	-----------------------------	----

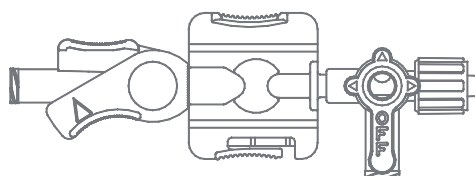

LogiCal® Pressure Transducer System Component

ORDERING INFORMATION

LogiCal® Reusable Transducer

Code	Description	Units per Case
MX960	LogiCal® Reusable Transducer Mounting Plate	5

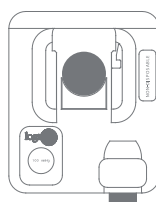



CLOSED BLOOD SAMPLING SYSTEMS

Add-On Closed Blood Sampling	16
TranStar® Kids Kit™ Neonatal Closed Blood Sampling System	18
TranStar® HemoDraw® Plus Single Line Closed Blood Sampling System	19
TranStar® HemoDraw® Plus Double Line Closed Blood Sampling System	20
TranStar® HemoDraw® Plus Triple Line Closed Blood Sampling System	21
LogiCal® Kids Kit™ Neonatal Closed Blood Sampling System	22
LogiCal® HemoDraw® Plus Single Line Closed Blood Sampling System	23
LogiCal® HemoDraw® Plus Double Line Closed Blood Sampling System	24
LogiCal® HemoDraw® Plus Triple Line Closed Blood Sampling System	24

Add-On Closed Blood Sampling Kits

ORDERING INFORMATION

Add-On Kids Kit™ NeoNatal Closed Blood Sampling

Code	Description	Units per Case
MX4133	19" (48 cm) Closed Blood Sample Kit	10

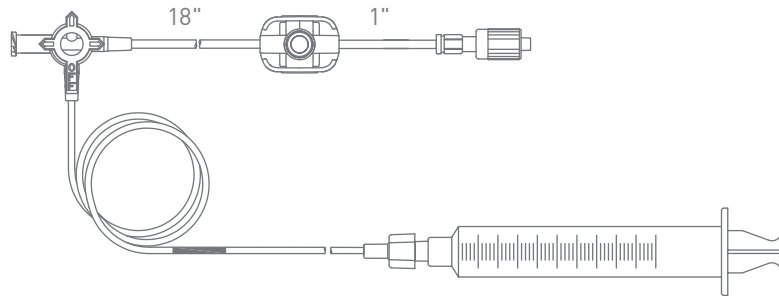

MX4137	1" (3 cm) Closed Blood Sample Kit	10
--------	-----------------------------------	----

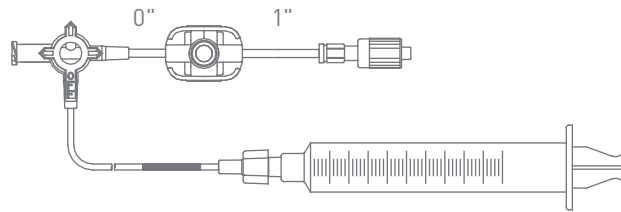

Add-On HemoDraw® Plus Closed Blood Sampling

Code	Description	Units per Case
MX401R151	HemoDraw® Plus blood sampling 152 cm/60" add on kit with one sampling site	10



TranStar® Kids Kit™ Neonatal Closed Blood Sampling System

ORDERING INFORMATION

TranStar® Kids Kit™ Neonatal Closed Blood Sampling System

Code	Description	Units per Case
MX9543	TranStar® Kids Kit™ 19" (48 cm) Closed Blood Sample Set (Neonatal)	10

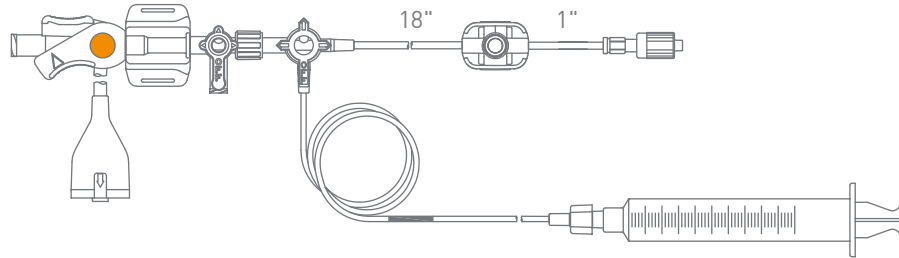

MX9544	TranStar® Kids Kit™ 31" (79 cm) Closed Blood Sample Set (Neonatal)	10
--------	--	----

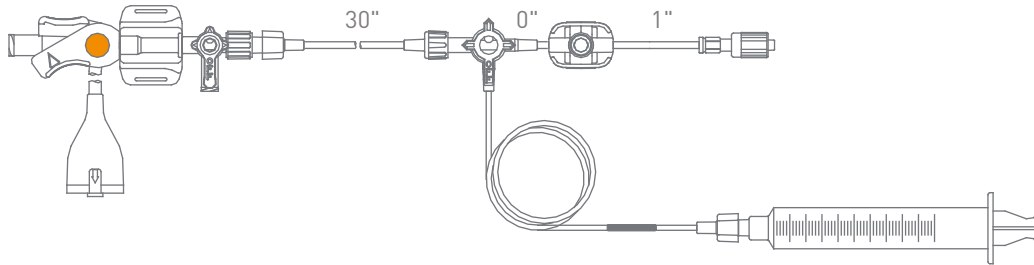

MX9545	TranStar® Kids Kit™ 34" (86 cm) Closed Blood Sample Set (Neonatal)	10
--------	--	----

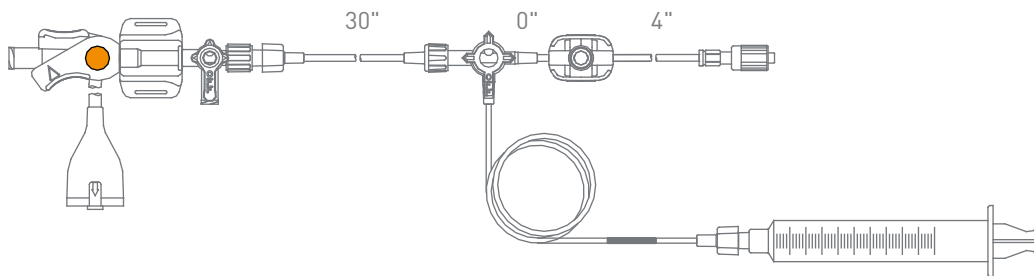

TranStar® Kids Kit™ Neonatal Closed Blood Sampling System

ORDERING INFORMATION

TranStar® Kids Kit™ Neonatal Closed Blood Sampling System

Code	Description	Units per Case
MX9547	TranStar® Kids Kit™ 7" (18 cm) Closed Blood Sample Set (Neonatal)	10

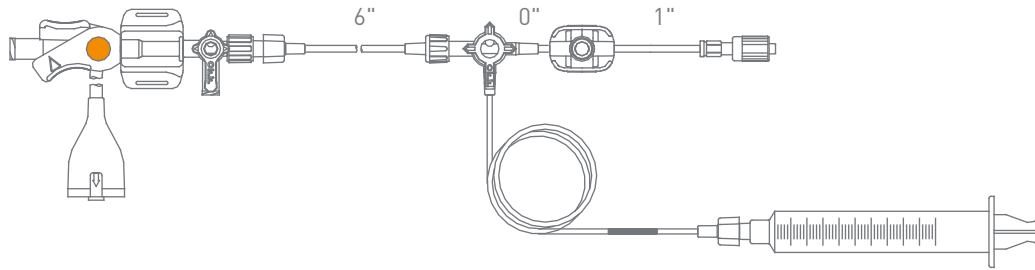

MX9548	TranStar® Kids Kit™ 10" (25 cm) Closed Blood Sample Set (Neonatal)	10
--------	--	----

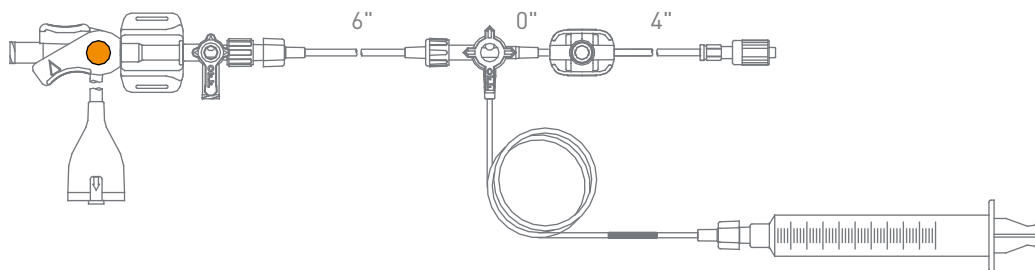

TranStar® HemoDraw® Plus Single Line Closed Blood Sampling System

ORDERING INFORMATION

TranStar® HemoDraw® Plus Single Line Closed Blood Sampling System

Code	Description	Units per Case
MX951R181	TranStar® 183 cm/72" Single Line HemoDraw® Plus blood sampling kit with one sampling site, arm mounted	10

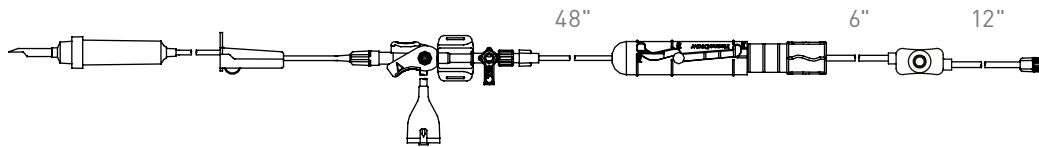

MX951H181	TranStar® 183 cm/72" Single Line HemoDraw® Plus blood sampling kit with one sampling site	10
-----------	---	----

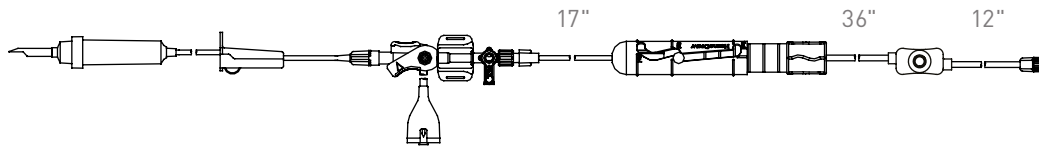

MX951H211	TranStar® 213 cm/84" Single Line HemoDraw® Plus blood sampling kit with one sampling site	10
-----------	---	----

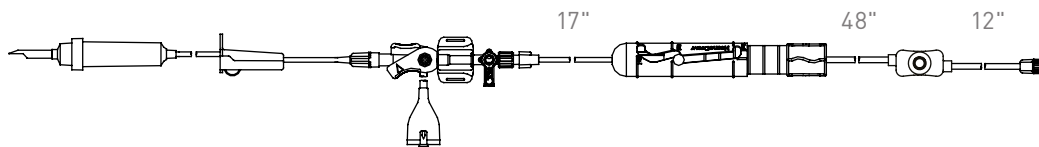

MX951H182	TranStar® 183 cm/72" Single Line HemoDraw® Plus blood sampling kit with two sampling sites	10
-----------	--	----

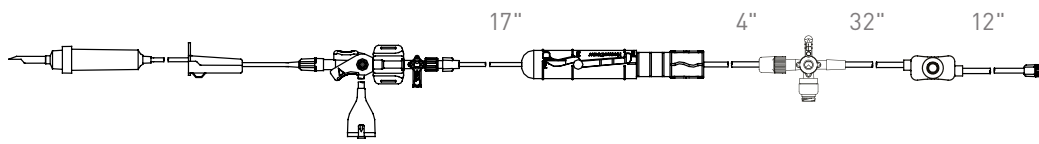

MX951H212	TranStar® 213 cm/84" Single Line HemoDraw® Plus blood sampling kit with two sampling sites	10
-----------	--	----

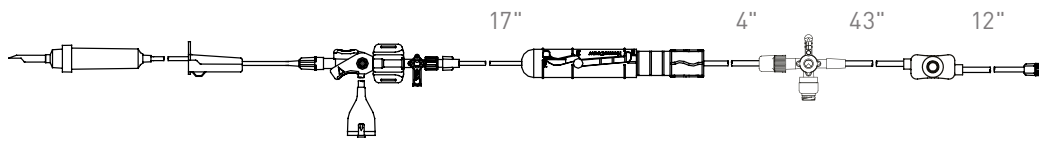

TranStar® HemoDraw® Plus Double Line Closed Blood Sampling System

ORDERING INFORMATION

TranStar® HemoDraw® Plus Double Line Closed Blood Sampling System		
Code	Description	Units per Case
MX952R181	TranStar® 183 cm/72" Double Line HemoDraw® Plus blood sampling kit with one sampling site, arm mounted	10
MX952H181	TranStar® 183 cm/72" Double Line HemoDraw® Plus blood sampling kit with one sampling site	10
MX952H182	TranStar® 183 cm/72" Double Line HemoDraw® Plus blood sampling kit with two sampling sites	10

TranStar® HemoDraw® Plus Triple Line Closed Blood Sampling System

ORDERING INFORMATION

TranStar® HemoDraw® Plus Triple Line Closed Blood Sampling System		
Code	Description	Units per Case
MX953H182	TranStar® 183 cm/72" Triple Line HemoDraw® Plus blood sampling kit with two sampling sites	10

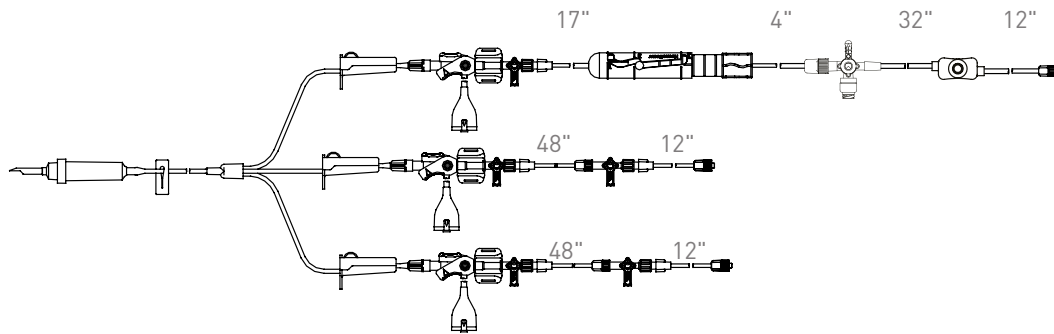

LogiCal® Kids Kit™ Neonatal Closed Blood Sampling System

ORDERING INFORMATION

LogiCal® Kids Kit™ Neonatal Closed Blood Sampling System

Code	Description	Units per Case
MX9644	LogiCal® Kids Kit™ 31" (76 cm) Closed Blood Sample Set (Neonatal)	10

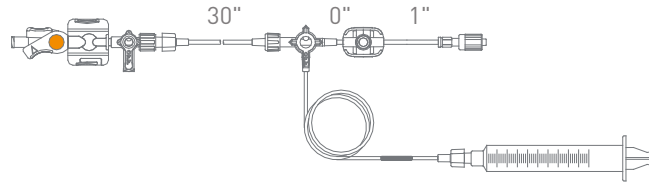

MX9645	LogiCal® Kids Kit™ 34" (83 cm) Closed Blood Sample Set (Neonatal)	10
--------	---	----

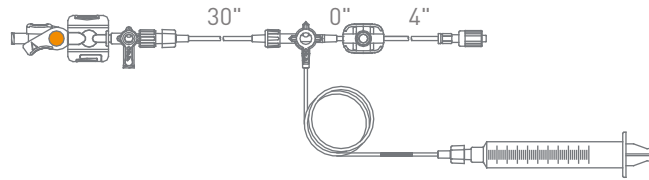

MX9647	LogiCal® Kids Kit™ 7" (18 cm) Closed Blood Sample Set (Neonatal)	10
--------	--	----

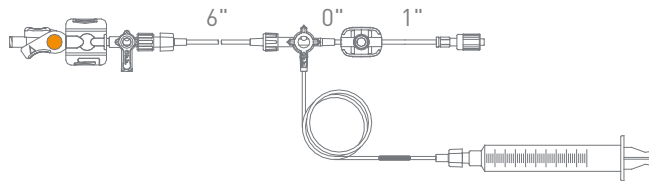

MX9648	LogiCal® Kids Kit™ 10" (25 cm) Closed Blood Sample Set (Neonatal)	10
--------	---	----

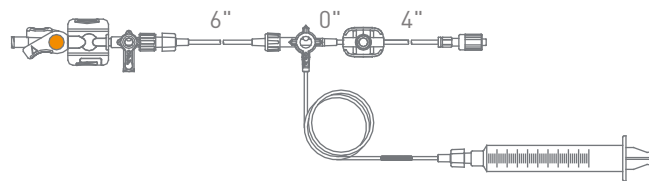

LogiCal® HemoDraw® Plus Single Line Closed Blood Sampling System

ORDERING INFORMATION

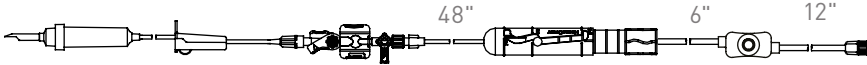
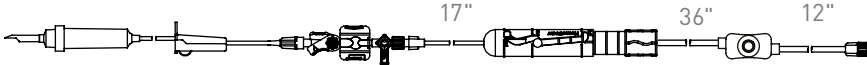
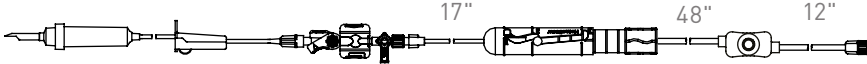
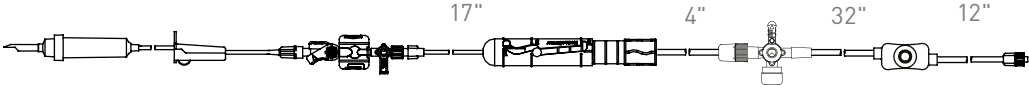
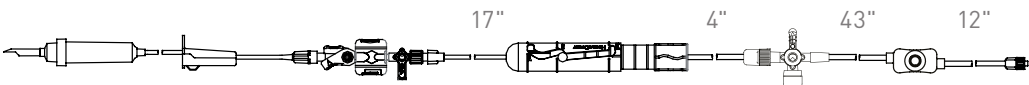
LogiCal® HemoDraw® Plus Single Closed Blood Sampling System		
Code	Description	Units per Case
MX961R181	LogiCal® 183 cm/72" Single line HemoDraw® Plus blood sampling kit with one sampling site, arm mounted	10
		
MX961H181	LogiCal® 183 cm/72" Single line HemoDraw® Plus blood sampling kit with one sampling site	10
		
MX961H211	LogiCal® 213 cm/84" Single line HemoDraw® Plus blood sampling kit with one sampling site	10
		
MX961H182	LogiCal® 183 cm/72" Single line HemoDraw® Plus blood sampling kit with two sampling sites	10
		
MX961H212	LogiCal® 213 cm/84" Single line HemoDraw® Plus blood sampling kit with two sampling sites	10
		

LogiCal® HemoDraw® Plus Double Line Closed Blood Sampling System

ORDERING INFORMATION

LogiCal® HemoDraw® Plus Double Closed Blood Sampling System		
Code	Description	Units per Case
MX962R181	LogiCal® 183 cm/72" Double line HemoDraw® Plus blood sampling kit with one sampling site, arm mounted	10
MX962H181	LogiCal® 183 cm/72" Double line HemoDraw® Plus blood sampling kit with one sampling site	10
MX962H182	LogiCal® 183 cm/72" Double line HemoDraw® Plus blood sampling kit with two sampling sites	10

LogiCal® HemoDraw® Plus Triple Line Closed Blood Sampling System

ORDERING INFORMATION

LogiCal® HemoDraw® Plus Triple Line Closed Blood Sampling System		
Code	Description	Units per Case
MX963H182	LogiCal® 183 cm/72" Triple Line HemoDraw® Plus blood sampling kit with two sampling sites	10

ACCESSORIES AND COMPONENTS

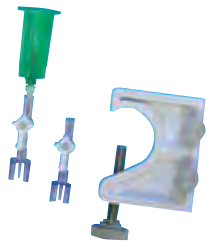

TranStar® Mounting Accessories.....	28
LogiCal® Mounting Accessories	28
Blood Sampling Access Devices	29
HemoDraw® Plus Mounting Accessories	29
Flush Devices.....	30
Pressure Monitoring Tubing with Male/Female Luer Lock.....	30
Pressure Monitoring Tubing with Male/Male Luer Lock	31
Pressure Monitoring Tubing with Male/Female Luer Lock (Red).....	31
Pressure Monitoring Tubing with Male/Female Luer Lock (Low Volume)	31
Non-Vented Administration Sets.....	32
Pressure Monitoring Components	33
Manometers.....	34

TranStar® Mounting Accessories

ORDERING INFORMATION

TranStar® Mounting Accessories		
Code	Description	Units per Case
MX800	TranStar® Modular Transducer Mounting Plates	20
MX240	TranStar® Pole Clamp for Mounting a Transducer Plate (Fits 3/4" to 1 1/2" IV Pole)	1
MX244	TranStar® Pole Clamp for Mounting a Transducer Plate (Fits 3/8" to 1" IV Pole)	1
MX800S	Armband for Patient Monitoring	10

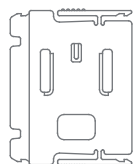

MX800

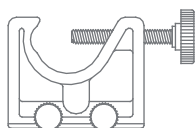

MX240



MX244



MX800S

LogiCal® Mounting Accessories

ORDERING INFORMATION

LogiCal® Mounting Accessories		
Code	Description	Units per Case
MX261	IV Pole Clamp with Bracket for 1 Transducer Mount Plate	1
MX262	Bracket for 2 Transducer Mounting Plates	1
MX263	Bracket for 3 Transducer Mounting Plates	1
MX264P1	Bracket for 4 Transducer Mounting Plates	1
MX260PM	Armband for Patient Mount 1 Transducer Mounting Plate	50

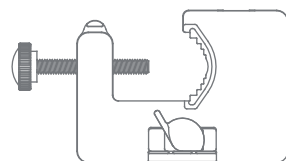

MX261

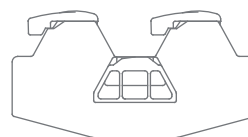

MX262



MX263



MX264P1



MX260PM

Blood Sampling Access Devices

ORDERING INFORMATION

Blunt Cannula Needle Free Access Device

Code	Description	Units per Case
MX920NF	Blunt Cannula Needle Free Access Device	100

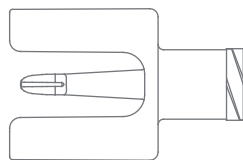

MX921NF	Needle-free Access Device with 1-Way Stopcock	50
---------	---	----

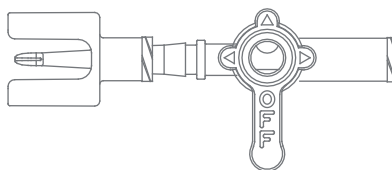

MX922NF	Needle-free Access Device with Vacuum Tube Holder	25
---------	---	----

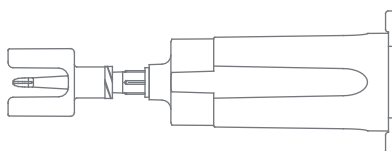

MX923NF	Needle-free Access Device with 1-Way Stopcock and Vacuum Tube Holder	25
---------	--	----

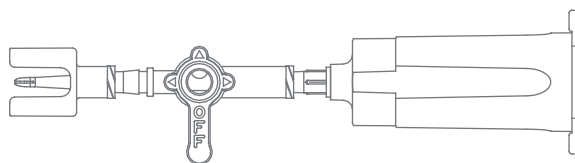

HemoDraw® Plus Mounting Accessories

ORDERING INFORMATION

Reservoir Bracket

Code	Description	Units per Case
MX257C1	Reservoir Bracket for TranStar® Mounting Plate	50
MX267C1	Reservoir Bracket for LogiCal® Mounting Bracket	50

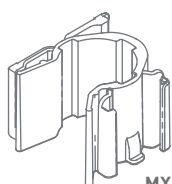

MX257C1

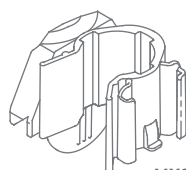

MX267C1

Flush Devices

ORDERING INFORMATION

Flush Devices		
Code	Description	Units per Case
MX503A	2-4 cc/hr Flush Device with Locknut	50

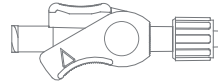

MX503GYA	2-4 cc/hr Trigger Flush	50
----------	-------------------------	----



Pressure Monitoring Tubing with Male/Female Luer Lock

ORDERING INFORMATION

Pressure Monitoring Tubing		
Code	Description	Units per Case
MX560	6" (15.2 cm) PVC Pressure Monitoring Line	25
MX561	12" (30.5 cm) PVC Pressure Monitoring Line	25
MX562	24" (61.0 cm) PVC Pressure Monitoring Line	25
MX563	36" (91.4 cm) PVC Pressure Monitoring Line	25
MX563L	36" (91.4 cm) PVC Pressure Monitoring Line, for use with Linden Lock Nut	25
MX564	48" (121.9 cm) PVC Pressure Monitoring Line	25
MX566	72" (182.9 cm) PVC Pressure Monitoring Line	25
MX567	84" (213.4 cm) PVC Pressure Monitoring Line	25
MX568	96" (243.8 cm) PVC Pressure Monitoring Line	25



Pressure Monitoring Tubing with Male/Male Luer Lock

ORDERING INFORMATION

Pressure Monitoring Tubing		
Code	Description	Units per Case
MX570	6" (15.2 cm) PVC Pressure Monitoring Line	25
MX571	12" (30.5 cm) PVC Pressure Monitoring Line	25
MX572	24" (61.0 cm) PVC Pressure Monitoring Line	25
MX573	36" (91.4 cm) PVC Pressure Monitoring Line	25
MX574	48" (121.9 cm) PVC Pressure Monitoring Line	25
MX576	72" (182.9 cm) PVC Pressure Monitoring Line	25
MX578	96" (243.8 cm) PVC Pressure Monitoring Line	25



Pressure Monitoring Tubing with Male/Female Luer Lock (Red)

ORDERING INFORMATION

Pressure Monitoring Tubing		
Code	Description	Units per Case
MX540R	6" (15.2 cm) Guide Stripe PVC Pressure Monitoring Line	25
MX541R	12" (30.5 cm) Guide Stripe PVC Pressure Monitoring Line	25
MX542R	24" (61.0 cm) Guide Stripe PVC Pressure Monitoring Line	25
MX543R	36" (91.4 cm) Guide Stripe PVC Pressure Monitoring Line	25
MX544R	48" (121.9 cm) Guide Stripe PVC Pressure Monitoring Line	25
MX546R	72" (182.9 cm) Guide Stripe PVC Pressure Monitoring Line	25



Pressure Monitoring Tubing with Male/Female Luer Lock (Low Volume)

ORDERING INFORMATION

Pressure Monitoring Tubing		
Code	Description	Units per Case
MX661	12" (30.5 cm) Low Volume Polyethylene Pressure Monitoring Tubing	25
MX663	36" (91.4 cm) Low Volume Polyethylene Pressure Monitoring Tubing	25
MX664	48" (121.9 cm) Low Volume Polyethylene Pressure Monitoring Tubing	25
MX666	72" (182.8 cm) Low Volume Polyethylene Pressure Monitoring Tubing	25



Non-Vented Administration Sets

ORDERING INFORMATION

Fluid Administration and Extension Sets

Code	Description	Units per Case
MX821S	Fluid Administration Set	25



MX822S	Bifurcated Fluid Administration Set	25
--------	-------------------------------------	----

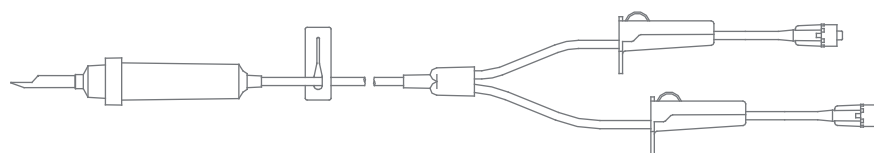



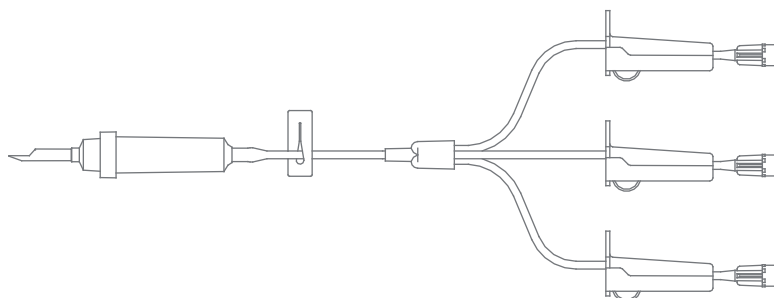

MX823S	Trifurcated Fluid Administration Set	25
--------	--------------------------------------	----

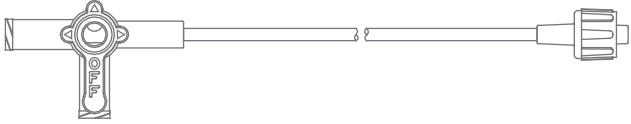

Pressure Monitoring Components

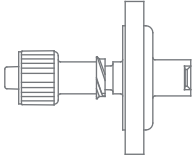
ORDERING INFORMATION

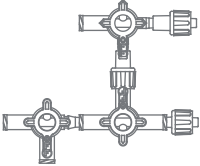
Components		
Code	Description	Units per Case
MX43660	6" (15 cm) Low Volume PVC Pressure Monitoring Extension with Male Luer Lock and 3-Way Stopcock	25
		
MX43661	12" (30 cm) Low Volume PVC Pressure Monitoring Extension with Male Luer Lock and 3-Way Stopcock	25
		
MX43860	6" (15 cm) Low Volume PVC Pressure Monitoring Extension with Male Luer Lock and 4-Way Stopcock	25
		
MX801	Hydrophobic Bacterial Filter with 0.22 Micron Air Filter	50
		
MX805	Hydrophobic Monitoring Line Filter with 0.45 Micron Filter and Male Luer Lock	25
		
MX999	PA-CVP Bridge	25
		

Manometers

ORDERING INFORMATION

Manometers		
Code	Description	Units per Case
MX441	35 cm Manometer Set: 4-Way Stopcock, 50" Extension Set with "Y" Site 3/4" from Male Luer Lock, includes 3/4" and 1" Pole Clamps	10

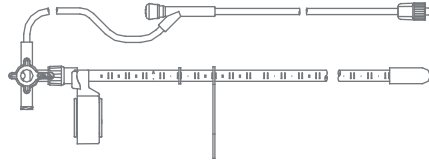

MX447	35 cm Manometer Set with 3-Way Stopcock, Hanger Strap	20
-------	---	----

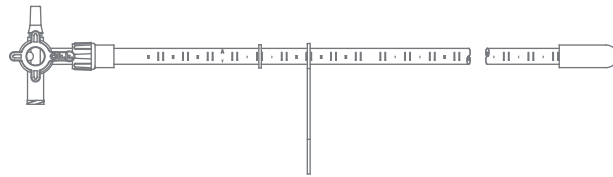

Pressure Monitoring Cables

ORDERING INFORMATION

Single, Double, Triple and Quad Channel Cables

Description

Pressure Monitoring cables to connect pressure transducers (TranStar® or LogiCal®) to patient monitors can be ordered by contacting Customer Service at 800.258.5361. Please specify the type of:

- Pressure Transducer (TranStar® or LogiCal®)
- Monitor Manufacturer Name
- Monitor Manufacturer Model Number
- Single, Double, Triple or Quad Branched Cables

LogiCal®

Single



Double



Triple



Quad



TranStar®

Single



Double



Triple



Quad



For more details on our cable offerings, please refer to the cable catalog MX195050EN.

Index

CODES

MX240.....	28	MX666.....	31	MX963H182.....	24
MX244.....	28	MX800.....	28	MX999.....	33
MX257C1.....	29	MX800S.....	28	MX1821B.....	4
MX260PM.....	28	MX801.....	33	MX1821G.....	4
MX261.....	28	MX805.....	33	MX4133.....	16
MX262.....	28	MX821S.....	32	MX4137.....	16
MX263.....	28	MX822S.....	32	MX4705.....	4
MX264.....	28	MX823S.....	32	MX4710.....	4
MX264P1.....	28	MX920NF.....	29	MX4805.....	4
MX267C1.....	29	MX921NF.....	29	MX4810.....	4
MX401R151.....	16	MX922NF.....	29	MX4830.....	4
MX441.....	34	MX923NF.....	29	MX9501T.....	8
MX447.....	34	MX950.....	10	MX9502T.....	9
MX503A.....	30	MX950L.....	10	MX9504T.....	8
MX503GYA.....	30	MX950SCFT.....	10	MX9505T.....	8
MX540R.....	31	MX950SCNT.....	10	MX9506T.....	9
MX541R.....	31	MX950X2SC.....	10	MX9510T.....	8
MX542R.....	31	MX950XSC.....	10	MX9513T.....	9
MX543R.....	31	MX951H181.....	19	MX9530T.....	8
MX544R.....	31	MX951H182.....	19	MX9535H001C1.....	21
MX546R.....	31	MX951H211.....	19	MX9543.....	17
MX560.....	30	MX951H212.....	19	MX9544.....	17
MX561.....	30	MX951R181.....	19	MX9545.....	17
MX562.....	30	MX952H181.....	20	MX9547.....	18
MX563.....	30	MX952H182.....	20	MX9548.....	18
MX563L.....	30	MX952R181.....	20	MX9601A.....	11
MX564.....	30	MX953H182.....	21	MX9602A.....	12
MX566.....	30	MX960.....	13	MX9604A.....	11
MX567.....	30	MX960SCFA.....	13	MX9605A.....	11
MX568.....	30	MX960X2SC.....	13	MX9606A.....	12
MX570.....	30	MX960XX.....	13	MX9625H003C1.....	24
MX571.....	30	MX960XY.....	13	MX9625H004C1.....	24
MX572.....	30	MX961H181.....	23	MX9630A.....	11
MX573.....	30	MX961H182.....	23	MX9644.....	22
MX574.....	30	MX961H211.....	23	MX9645.....	22
MX576.....	30	MX961H212.....	23	MX9647.....	22
MX578.....	30	MX961R181.....	23	MX9648.....	22
MX661.....	31	MX962H181.....	24	MX43660.....	33
MX663.....	31	MX962H182.....	24	MX43661.....	33
MX664.....	31	MX962R181.....	24	MX43860.....	33

For more information visit our website at www.smiths-medical.com

PRODUCT(S) DESCRIBED MAY NOT BE LICENSED OR AVAILABLE FOR SALE IN CANADA AND OTHER COUNTRIES

Smiths Medical ASD, Inc.
6000 Nathan Lane North
Minneapolis, MN, 55442, USA
Tel: 1-614-210-7300
Toll-Free USA 1-800-258-5361
www.smiths-medical.com

Find your local contact information at: www.smiths-medical.com/customer-support

Smiths Medical is part of the global technology business Smiths Group plc. Please see the Instructions for Use/Operator's Manual for a complete listing of the indications, contraindications, warnings and precautions. Medex, TranStar, Kids Kits, SECURE, HemoDraw, LogiCal, NovaTrans, Clear-Cuff, C-Fusor, and the Smiths Medical are trademarks of Smiths Medical. The symbol ® indicates the trademark is registered in the U.S. Patent and Trademark Office and certain other countries. All other names and marks mentioned are the trademarks or service marks of their respective owners. Product referenced is CE-marked. ©2018 Smiths Medical. All rights reserved. SM196407EN-052018

MDLBCA-1072

Rx
ONLY

smiths medical