



TRÚ *comfort*



Double Electric
Breast Pump
with collection combo kit



User Manual

Model: ROS-DBEL

Congratulations

Congratulations on your new Viverity® TrúComfort Electric Breast Pump! The Viverity® TrúComfort Electric Breast Pump is perfect for many occasions.

- Collecting breast milk while you're away from your baby
 - for example: when you're at work
- Relieving engorgement
 - for example: when your baby's feeding habits change because they're eating more solids
- Maintaining your milk supply if you have to temporarily stop breastfeeding
 - for example: to express unsuitable milk while you are undergoing medical treatment

The Viverity® TrúComfort Electric Breast Pump provides many of the features busy moms love.

- 4 speed modes and 7 levels of suction
- Milk back-flow protection
- Quiet motor for discretion
- Small and lightweight
- 2 power options to fit your needs
 - AC/DC Adapter
 - 4 AA Alkaline batteries (not included)

Indication for Use

The Viverity® TrúComfort Electric Breast Pump is a single user, electrical powered device used to express milk from the breasts of lactating women. This device is not intended for hospital use.

Table of Contents

Congratulations	1
Indication for Use	1
Important Safeguards	4
• DANGER	4
• CAUTION	4
• WARNING	4
Parts Guide	6
• Electrical Pump Main Unit	7
• Expression Collection Combo Kit	8
How to Assemble the Expression Collection Kit	9
How to Assemble Electric-Pump Diaphragm Kit	12
How to Assemble Expression Collection Combo Kit	13
Power Options	15
• Using your AC/DC Adapter (included)	15
• Using 4 AA Alkaline Batteries (Batteries not included)	16
• Install the Batteries (AA Alkaline)	17
Pumping Instructions	19
Cleaning Instructions	22
• Sanitize Prior to First Use	22
• Before Each Use	22
• General Cleaning Instructions	22
• Tubing Cleaning Instructions	23
Breastmilk Storage Guidelines	24
• Important Notes	24

Tips	26
• Pumping Tips	26
• Breastfeeding Tips	27
Troubleshooting	28
• Interruption of Electrical Service	28
• Radio Frequency Energy	28
• Decreased Suction	28
• Breastmilk Buildup in the Breastshield Body	29
• Pumping Doesn't Start	29
• Where to get Replacement Parts	29
• What Additional Accessories are Available	29
Technical Data	30
• Power Requirements	30
Warranty	31

Important Safeguards

The Viverity® TrúComfort Electric Breast Pump is designed for a single user and should never be shared or resold; doing so will void the warranty.

READ ALL INSTRUCTIONS BEFORE USING

DANGER: To reduce the risk of electrocution:

- Always unplug this product immediately after using.
- Do not use while bathing.
- Do not place or store this product where it can fall or be pulled into a tub or sink.
- Do not place or drop into water or other liquid.
- Do not reach for an electrical product that has fallen into water. Unplug immediately.

CAUTION:

- Do not use this product for any other purpose than as indicated in the Instructions and Assembly.
- Make sure all the parts are assembled correctly before operating.
- Stop using the breast pump immediately if your breasts or nipples experience any discomfort.
- Please wash hands before using this product.
- Keep this product out of reach of babies and children.
- Do not drop or hit the product to avoid damage.
- Do not touch the product with bare hands right after sterilizing by boiling water to avoid scalds and burns.
- Do not over-boil to avoid premature aging of the product materials.

WARNING: To reduce the risk of burns, electrocution, fire, or injury to persons:

- This product should never be left unattended when plugged in.
- Close supervision is necessary when this product is used near children or invalids.
- Use this product only for its intended use as described in this manual. Do not use attachments or parts not recommended by Viverity®.
- Do not operate this product if it has a damaged cord or plug, if it is not working properly, if it has been dropped or damaged, or if it has been dropped in water.
- Keep the cord away from heated surfaces.
- Do not use while sleeping or drowsy.
- Do not drop or insert any object into any opening or tubing.
- Do not use outdoors with the AC/DC Adapter or operate where aerosol spray products are being used, or where oxygen is being administered.

Important Safeguards (Continued)

- Make sure the voltage of the AC/DC Adapter is compatible with the power source.
- Plug the AC/DC Adapter into the electrical outlet first, then plug the power cord into your Viverity® Electric Breast Pump.
- Viverity has provided an AC/DC Adapter with this device. Using any other AC/DC Adapter not approved by the manufacturer voids the warranty.
- If you are infected with Hepatitis A, Hepatitis B, or have HIV (Human Immunodeficiency Virus): pumping breast milk does not reduce or remove the risk of transmitting the virus to your baby through breast milk.
- Wash the Expression Collection Combo Kit parts before each use.
- Do not operate a motor vehicle while using the Viverity® Electric Breast Pump.
- Do not attempt to modify the product.

SAVE THESE INSTRUCTIONS along with your receipt for future reference.

Parts Guide

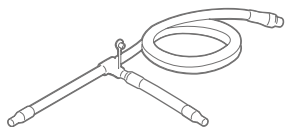

Vacuum Tubing with Adapter

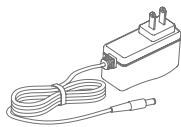

AC/DC Adapter



Spare Parts
(2 Valve and 4 O-Ring)



Breast Pump Main Unit

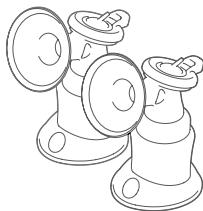

Expression Collection Combo Kit

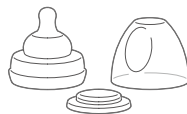

Bottle Adapter Kit (Set of 2)

Parts Guide

• Electrical Pump Main Unit

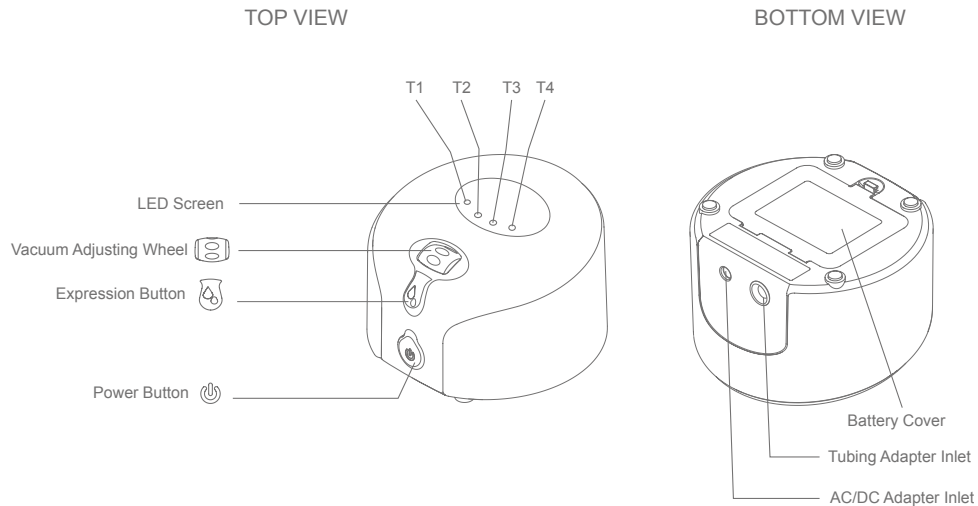

Parts Guide

● Expression Collection Combo Kit

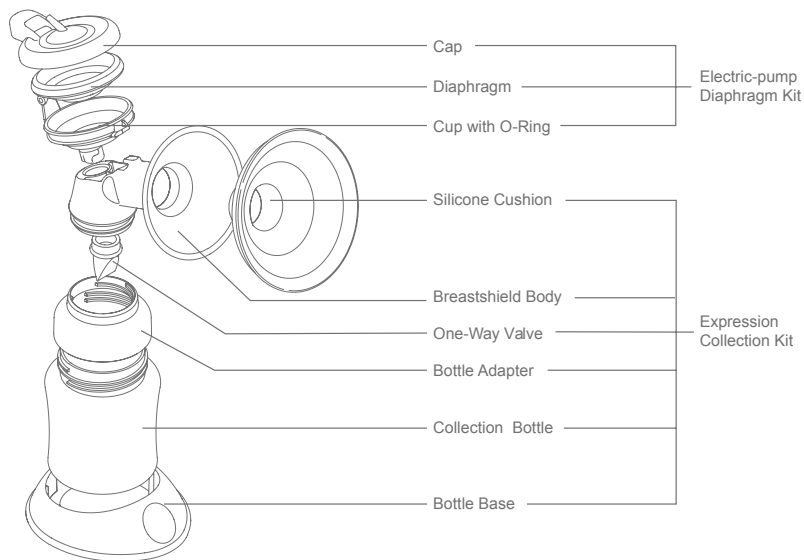

How to Assemble the Expression Collection Kit

Your Viverity® Electric Breast Pump comes pre-assembled; however, you will need to re-assemble it after each cleaning (For cleaning instructions, see page 22). Below is a step-by-step guide for assembling the Expression Collection Kit:

1. Hold the "horn" of the Breastshield Body in one hand. Make sure the bottle-thread side opening is facing up.



2. With the thumb and forefinger of the other hand, hold the tip of the One-Way Valve and place the flat circular bottom into the opening. Be sure not to stretch, bend, or twist the tip of the One-Way Valve. Seal all the edges firmly.

Note: The One-Way Valve tip does not have to align with anything, as long as all the edges are securely sealed.

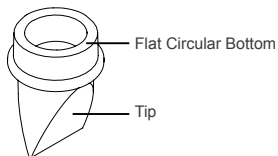

How to Assemble the Expression Collection Kit (Continued)

3. With your thumb and forefinger, gently seal any openings on the tip of the One-Way Valve and shape into a straight line.

Note: This is critical to the performance of the pump.

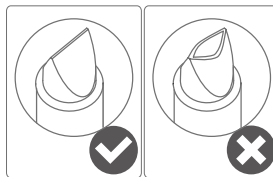

4. Carefully twist on the Bottle Adapter to the Breastshield Body for a secure fit.

Note: Be sure not to bump the One-Way Valve when twisting the Breastshield Body and the Bottle Adapter pieces together. If you bump the One-Way Valve, repeat step 3.



How to Assemble the Expression Collection Kit (Continued)

5. With the Bottle Adapter in one hand, twist on the Collection Bottle for a secure fit.



How to Assemble Electric-pump Diaphragm Kit

1. With the Cup in one hand, place the Diaphragm in the Cup (matching the shape of the Cup). Press around the edges of the Diaphragm for a secure fit. Make sure the Diaphragm is evenly mounted on the Cup and there is no gap in between them.



2. Place the Cap on the Cup & Diaphragm. (Be sure to align the hinge and hinge cover.) Press tightly to seal.



How to Assemble the Expression Collection Combo Kit

1. With the O-Ring side down, put the Electric Pump Diaphragm Kit into the top of the Breastshield Body opening. Twist the Electric-Pump Diaphragm Kit clockwise into the Breastshield Body until it locks into place.

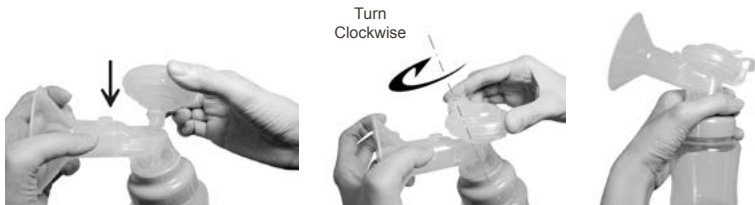

2. Take the open-end of Vacuum Tubing (the end without the adapter) and connect to the Tubing Connector located on the Cap. Push together firmly for a tight seal.

Note: Make sure there is no moisture in the Tubing.

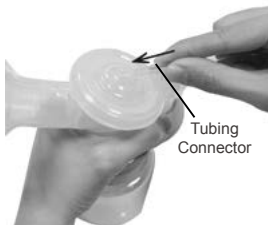

How to Assemble the Expression Collection Combo Kit (Continued)

3. With the Breastshield Body in one hand, place the Silicone Cushion in the Breastshield Body (matching the shape of the horn). Secure the lip of the Cushion around the edges of the horn.

Note: Your Electric Breast Pump will work with or without the Silicone Cushion. Your comfort depends on your preference.



4. Take the open-end of Vacuum Tube (the end without the adapter) and connect to the Tubing Connector located on the Cap. Push together firmly for a tight seal.

Note: Make sure there is no moisture in the tubing.

*** To Use As a Single Pump:**

Remove one tube and close the T-connector.

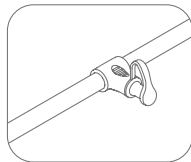
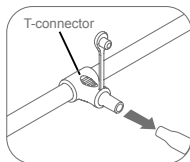

5. Make sure the Tubing Connector is properly inserted into the Tubing Adapter Inlet on the Electric Pump Main Unit.



Power Options

Your Electric Breast Pump may be operated under any of the following power supply modes:

Using your AC/DC Adapter (included):

- Electrical safety can only be achieved when using the AC/DC Adapter which was provided with the pump. Use of any other Adapters causes concern for the safety of the product and/or the user and voids the warranty.

1. Plug the AC/DC Adapter into an electrical outlet.



2. Attach the Power Cord to the AC/DC Adapter Inlet on the Electric Pump Main Unit.



Using 4 AA Alkaline Batteries (not included):

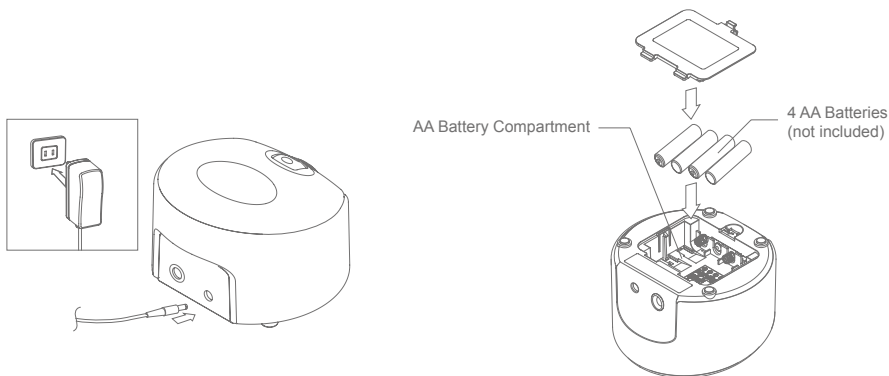

- Always replace all 4 AA Batteries at the same time.
- Remove all batteries from the Electric Pump Main Unit if the Pump is not going to be used for extended periods of time.
- Properly dispose of all batteries, according to government regulations for environmental protection and recycling.

Note: Alkaline Batteries may present a risk of fire or chemical burn if mistreated. Do NOT disassemble any battery. Do NOT place batteries near heat source or fire. Dispose of used batteries properly. Do NOT dispose of batteries in fire. Keep away from children.

Install the Batteries(AA Alkaline):

1. Open the Battery Cover.



2. Remove the old batteries if you are replacing them and properly dispose of them.



Install the Batteries AA Alkaline (Continued):

3. Insert 4 new AA Alkaline Batteries.

Note: Make sure the polarity is correct as indicated.

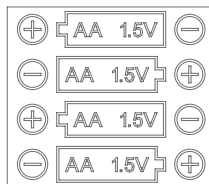

4. Close the Battery Cover, making sure it "snaps" into place.



Pumping Instructions

1. Hold the Expression Collection Kit to your breast so that your nipple is centered inside the Breastshield.

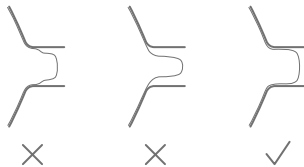

Note: Please check for correct fitting of the shield.

2. Press the Power Button  to begin pumping.



Pumping Instructions (Continued)

3. Start pumping with T1 speed. T1 LED on top panel lights up.



4. If you prefer a different pumping speed, just press the Expression Button to switch between 4 different speed modes. Suction speed gradually slows down from T1 to T4.

Note: The Expression suction speed is switched in following sequence: T1 -> T2 -> T3 -> T4 -> T3 -> T2 -> T1.

T1 (fastest) and T4 (slowest)



Pumping Instructions (Continued)

5. Adjust the suction to your comfort level by rolling the Vacuum Adjusting Wheel. The current level is shown with the number marked on the Vacuum Adjusting Wheel. The suction power gradually increases from 1 to 7.



6. When your pumping session is finished, turn the pump off by pressing the Power Button .

Note: Make sure there is no suction on the nipples before removing the Breastshield. If necessary, break the suction by inserting a finger between the Breastshield and the breasts, similar to the way you break away from your baby's suction.



Note: If the Viverity® Electric Breast Pump is left on, but unattended for more than 30 minutes, the Pump will automatically shut-off.

Cleaning Instructions

Unless otherwise instructed by your healthcare provider, follow these sanitizing and cleaning instructions.

Sanitize Prior to First Use:

Before you use your Viverity® Electric Breast Pump for the first time, disassemble and boil all parts of the Expression Collection Combo Kit in water for 10 minutes.

- Be sure to use enough water to keep all parts afloat while boiling.
- **Do NOT boil Tubing or Tubing Adapter.**
- Remove all parts from the water immediately after sterilizing. To avoid scalds and burns, do NOT touch the product with bare hands right after sterilizing.
- Completely air-dry or towel-dry before reassembling for next use.

Partially dry components may affect the operation of your Electric Breast Pump. Please ensure that all parts are completely dry before use.

Before Each Use:

- Wash your hands thoroughly with soap and warm water before handling the Electric Breast Pump or any Expression Collection parts or attachments.
- Make sure all parts are clean and dry.
- Ensure the tubing is free from any liquid. **Do NOT operate your Viverity® Electric Breast Pump if any liquid is visible in the tubing. (See Tubing Cleaning Instructions on page 23.)**

General Cleaning Instructions:



Caution: Take care when cleaning the One-Way Valve. If it gets damaged, your breast pump will not function properly. To clean the One-Way Valve, rub it gently between your fingers in warm soapy water, then rinse thoroughly in clean warm water. Do not insert any objects into the One-Way Valve as this may damage the valve.

- Set aside the tubing and tubing Connector. Under the normal working conditions of the pump, the diaphragm prevents the back-flow of milk. Therefore, these items do not need to be washed. In case of finding any liquid or liquid vapor inside the tubing, follow the Tubing Cleaning Instructions (on page 23) carefully before use.
- All parts of the Expression Collection Combo Kit may be cleaned in the upper compartment of your dishwasher or hand washed with dish soap in hot water.

Cleaning Instructions (Continued)

- Do NOT use solvents or abrasives.
- Rinse with hot, clean water.
- To clean the Electric Pump Main Unit, wipe it with a wet wipe or damp cloth, using only water or water mixed with a mild soap.

Tubing Cleaning Instructions:

- Wipe the outside of the tubing with a clean, damp cloth. Avoid getting water or other fluids inside the tubing.
- If liquids are found inside tubing, rinse the tubing with clean hot water. Hang to AIR DRY COMPLETELY BEFORE USING. Do NOT insert any object into the tubing.

Note: *Before each use-visually inspect the individual components for cracks, chips, tears, discoloration or deterioration; as they may affect the efficiency of the Viverity® Electric Breast Pump. In the event that damage to the device is observed, please discontinue use until the parts have been replaced.*

Breastmilk Storage Guidelines

Check with your healthcare provider or an International Board Certified Lactation Consultant for specific storage instructions. This information is based on current research and applies to mothers who have healthy, full-term babies who are storing their milk for home use.

Important Notes:

- **STORAGE CONTAINERS:** The best option for storing human milk is glass or hard-sided plastic containers with well-fitting tops. When you are freezing your breastmilk, do not fill the container more than 3/4 full to allow for expansion from freezing. Store milk in the main refrigerator or freezer compartment, away from the door, to avoid changes in temperature that may compromise the milk.
- **RE-WARMING THE FROZEN MILK:** Frozen milk can be thawed in the refrigerator overnight or under cool running water. Gradually increase the temperature of the water to heat the milk to feeding temperature. Be sure to use thawed milk within 24 hours. Discard any leftovers.
- **RE-WARMING THE REFRIGERATED MILK:** Refrigerated milk can be warmed by running under warm water for several minutes. ALWAYS test the temperature of the milk on the inside of your wrist before feeding it to your baby. The milk should feel warm, not hot.
- **WHAT TO DO:** Storing milk in 2 to 4 oz amounts may reduce waste. Write the date you expressed your milk on the container (include your baby's name on the label if your baby is in a daycare setting). Use the oldest milk first. Throw away previously frozen milk that is not used within 24 hours.
- **WHAT NOT TO DO:** Do NOT heat milk directly on the stove. Do NOT thaw in hot or boiling water. Do NOT microwave milk, as microwaving alters the composition of the milk and may create hot spots that may burn your baby. Do NOT refreeze thawed milk.
- **NOTE:** Human milk may separate into a milk layer and a cream layer when it is stored. This is normal. Gently swirl to redistribute the cream before giving to baby. Sometimes thawed milk may smell or taste soapy. This is due to a breakdown in the milk fats. The milk is safe and most babies will still drink it.
- **STORAGE:** Expressed milk can be kept in a common refrigerator at the workplace or day care center. The US Center for Disease Control (CDC) and the US Occupational Safety and Health Administration (OSHA) agree that human milk is not among the body fluids that require special handling or storage in a separate container.

Breastmilk Storage Guidelines (Continued)

Place	Temperature	How long	Things to know
Refrigerator	39°F or colder	<ul style="list-style-type: none"> ● Up to 72 hours is best. ● Up to 5-8 days is okay for very clean expressed milk. 	Store milk in the back of the main body of the refrigerator.
Freezer	0°F or colder	<ul style="list-style-type: none"> ● Up to 6 months is best. ● Up to 12 months is okay. 	Store milk toward the back of the freezer where temperature is most constant. Milk stored at 0°F or colder is safe for longer durations, but the quality of the milk might not be as high.
Smaller cooler with a blue-ice pack.	59°F	24 hours	Keep ice packs in contact with milk containers at all times; limit opening cooler.
Countertop, table	Room temp (60°F - 85°F)	<ul style="list-style-type: none"> ● Up to 3-4 hours is best. ● Up to 6-8 hours is okay for very clean expressed milk. 	Containers should be covered and kept as cool as possible; covering the container with a clean cool towel may keep milk cooler. Throw out any leftover milk within 1 to 2 hours after the baby is finished feeding.

CAUTION: Do not refreeze thawed milk. Discard any remaining thawed milk if not used within 24 hours.

Tips

Pumping Tips:

The most important and successful part of pumping is the let-down reflex. The let-down reflex is when your milk begins to flow freely.

- Try relaxing with a warm, wet compress on your breasts.
- Drink plenty of fluids.
- Avoid outside distractions.
- Visualize yourself happy, well rested and successful at pumping.
- Sometimes a light circular massaging of the breasts prior to and/or during a pumping session will help your let-down reflex start/continue.
- Go to a non-stressful environment.
- Use a comfortable chair that gives lower back support with or without a footstool. After all, you're the one who has to be comfortable.

Depending on your health and milk production condition, you may be able to achieve more than one let down in one pumping session. Most mothers have more than one let-down while breast feeding and don't even notice the change. To achieve multiple let-downs which mimics the natural reflex found in breast feeding, you can switch the suction speeds T1 (fastest) and T4 (slowest) just by pressing the Expression Button. The suction speed is switched in the following sequence T1 -> T2 -> T3 -> T4 -> T3 -> T2 -> T1.

Remember that successful pumping is a learned skill. Don't get discouraged, and keep working at it to obtain the best results. Breastmilk is produced on a supply and demand basis; expressing your breastmilk regularly stimulates and maintains your milk supply.

If it feels uncomfortable or painful on your breasts while using the pump, try decreasing the suction level by rolling the Vacuum Adjusting Wheel down (-). If these tips do not help, turn the product off and remove the pump from your breasts for a few minutes. If you are still experiencing pain or discomfort, consult your healthcare professional or an international board certified lactation consultant.

Tips (Continued)

Breastfeeding Tips:

- The Viverity[®] Electric Breast Pump helps you maintain a supply of milk and can help you prepare for planned events such as "Date Night" or unexpected events such as power outages, medical treatment, or relief from tender nipples.

Troubleshooting

Interruption of Electrical Service:

If you experience an interruption of electrical service, due to a power surge or other factors, during normal operation of your Viverity® Electric Breast Pump, try the following:

- Unplug the AC/DC Adapter cord from the electrical outlet and wait for five seconds before plugging the AC/DC Adapter cord back into the electrical outlet.
- Try a different electrical outlet in another room or on a different circuit.

Radio Frequency Energy:

This equipment generates, uses, and can radiate radio frequency energy. If not installed properly and used in accordance with the instructions; it may cause harmful interference with other devices in the vicinity. Try the following:

- Reorient or relocate the device receiving interference.
- Increase the distance between the equipment.
- Connect the equipment into an outlet on a different circuit from that which the other device(s) are connected.
- Consult the manufacturer or a field service technician of the device receiving interference for help.
- There is no guarantee that interference will not occur.

Decreased Suction:

If it feels like the suction has decreased, try the following:

- Make sure the Expression Collection Combo Kit is assembled correctly (see pages 9-14).
 - Inspect the One-Way Valve for any tears or pinholes. This component is critical to achieving proper suction. If damaged, replace the One-Way Valve with one of the spare valves that is provided with your Viverity® Electric Breast Pump.
- Detach the Tubing and Tubing Adapter from the back of your Electric Breast Pump and place a finger over the Tubing Adapter Inlet.
 - If you do feel suction, the Electric Pump Base is operating properly.
 - If you do NOT feel suction or feel that the suction has decreased to an unexpected strength; contact your local DME dealer/retailer where you purchased the unit from for warranty service (see Page 31).

Troubleshooting (Continued)

Breastmilk Buildup in the Breastshield Body:

If breastmilk doesn't appear to be draining fast enough into the Collection Bottle, reduce the suction setting on your Electric Breast Pump to allow the milk to drain before gradually increasing.

Pumping Doesn't Start:

- Make sure the adapter is properly plugged.
- If you are using the battery, make sure the battery is fully charged.
- When battery runs low, power button (LED) flashes and then turn off automatically.

Where to get Replacement Parts:

If you are missing a part or need a replacement part, please contact your local DME dealer/retailer where you purchased the unit from.

Additional Accessories:

Parts	Part Number
• Bottle Set (6 sets)*.....	ROS-BOTTLESET
• Single Collection Kit*.....	ROS-SGKIT
• Double Collection Kit*.....	ROS-DBKIT
• One-Way Valve (4 pieces)*.....	ROS-1VLVE

**Bottle Set – Bottle, Cap, Sealing Disc, and Bottle Ring*
**Single Collection Kit – Cap, Diaphragm, Cup with O-Ring, Breast Shield, One Way Valve, Bottle Adapter, Collection Bottle and Bottle Base*
**Double Collection Kit – Cap, Diaphragm, Cup with O-Ring, Breast Shield, One Way Valve, Bottle Adapter, Collection Bottle and Bottle Base*
**One-Way Valve – Includes four (4) individual valves*

Technical Data

Power Requirements:

- AC/DC Adapter (included) North American Plug configuration:
Model:GDP12AV-1201000, 100V ~ 240V AC, 50/60 Hz, 0.45A, wall plug type AC/DC Adapter with DC 12V/1A output.
- Batteries:
4 AA Batteries; 1.5V Alkaline

Technical Specifications:

VACUUM:

T1 phase:-177mmHg(-23.6kpa)

T2 phase:-216mmHg(-28.9kpa)



T3 phase:-240mmHg(-32kpa)

T4 phase:-250mmHg(-33.4kpa)

Ambient temperature range:+10°C to 40°C (50°F to 104°F)

Relative Humidity range: 20% to 80%

Key to Box Symbol:

-  Type BF equipment (Breastshield)
-  Consult instructions for use
-  Disposal of Electrical & Electronic Equipment (WEEE)

Made in China

Manufactured by RumbleTuff

Warranty

Limited Consumer Product Warranty (United States)

This Viverity® TrúComfort Electric Breast Pump is warranted to the original consumer "the purchaser" to be free from defects in material and workmanship which are not commercially acceptable for the period of one year from the date of purchase on the pump mechanism and a period of 120 days on all other components. Warranty coverage terminates if you sell or otherwise transfer this product to another person. This warranty gives you specific legal rights and you may also have other rights, which vary by location.

VIVERITY® MAKES NO EXPRESS WARRANTY OF ANY KIND REGARDING THIS PRODUCT OTHER THAN THOSE WARRANTIES SET FORTH HEREIN. ANY IMPLIED WARRANTY, INCLUDING ANY IMPLIED WARRANTY OF MERCHANTABILITY OR ANY IMPLIED WARRANTY OF FITNESS FOR A PARTICULAR PURPOSE TO THE EXTENT PERMITTED BY LAW, SHALL BE LIMITED IN DURATION TO A PERIOD OF 120 DAYS FROM THE DATE OF PURCHASE BY THE ORIGINAL PURCHASER.

In the event that this product is found by Viverity® to not meet the above limited warranty, as purchaser's sole and exclusive remedy, Viverity® will repair or at the option of Viverity®, replace this product without charge for such replacement parts or labor. The purchaser shall bear all expenses related to returning this product to Viverity®. This warranty does not apply to any part of the product that has been subject to misuse, abuse, or alteration. Only Viverity® brand replacement parts are recommended for use with Viverity® breastfeeding products. Improper or incorrectly performed maintenance or repair, or use of non-Viverity® brand replacement parts voids this warranty.

TO THE EXTENT PERMITTED BY LAW, VIVERITY® SHALL NOT BE LIABLE FOR ANY INCIDENTAL OR CONSEQUENTIAL DAMAGES INCLUDING, BUT NOT LIMITED TO, REPLACEMENT COSTS RESULTING FROM THE BREACH OF ANY WRITTEN OR IMPLIED WARRANTY.

Warranty (Continued)

If you wish to make a claim under this warranty, please contact your local DME dealer/retailer where you purchased the unit from. You will need the following information when making your claim:

- The entire original Viverity® product and packaging
- The original receipt showing date of purchase
- Detailed description of the problem



Manufactured for



Roscoe Medical, Inc.
21973 Commerce Parkway
Strongsville, OH 44149 USA